

SPIROL[®]

**INNOVATIVE FASTENING SOLUTIONS.
LOWER ASSEMBLY COSTS.**

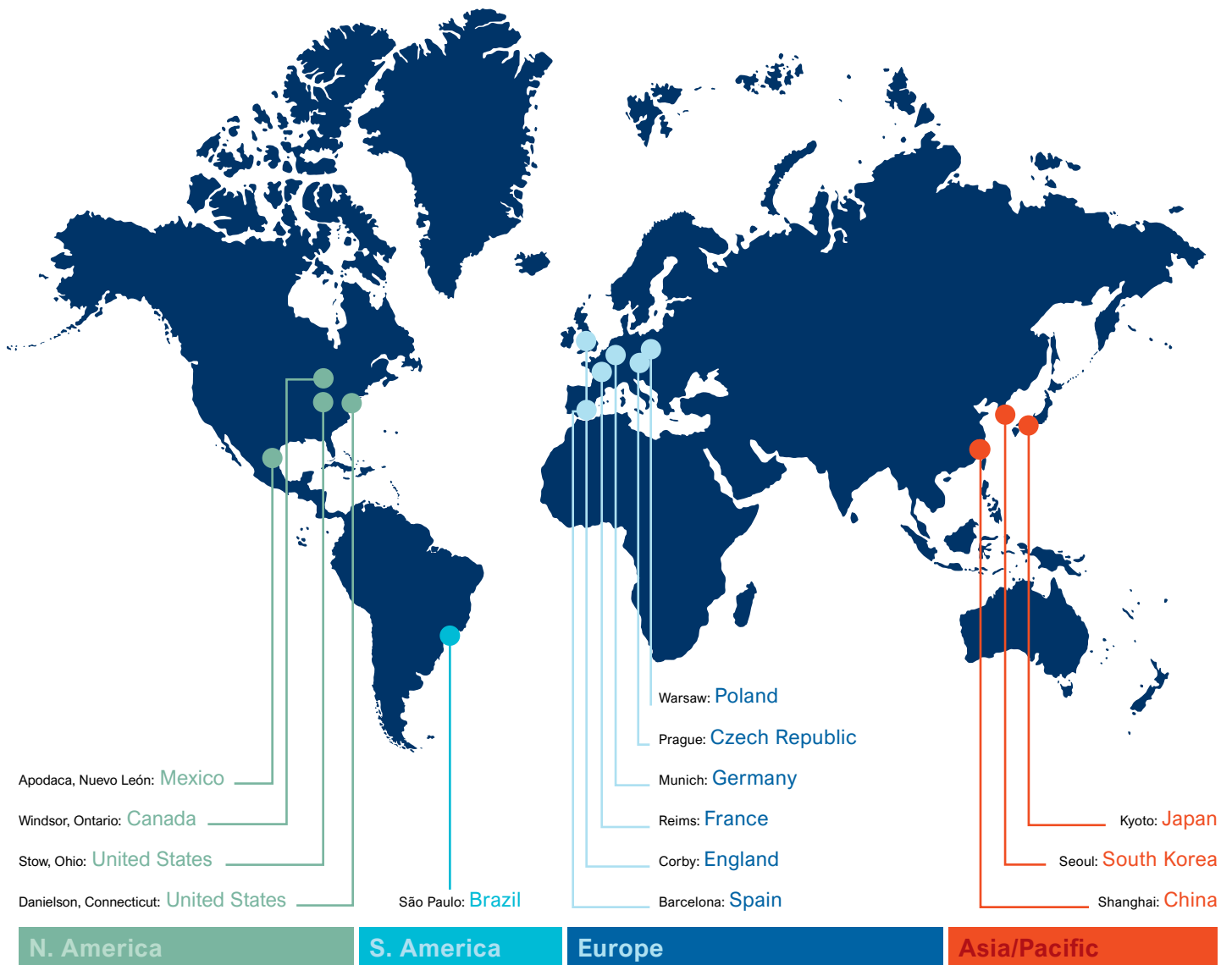



Local Design, Global Supply

SPIROL has Application Engineers throughout the world to assist you in your designs, supported by state-of-the-art manufacturing centres and worldwide stocking facilities to simplify the logistics of delivering your product.

Driven to enhance your competitiveness

SPIROL stands apart from all other companies in our industry. We are a technical resource that provides high quality components that improve the quality of your assembly, extend the life of your products and reduce your manufacturing costs.

Working with our customers to collaboratively innovate novel solutions sets us apart in the industry. Beginning with the invention of the Coiled Spring Pin in the 1940's, we have continuously introduced new products, as well as improved the performance of established lines, resulting in millions of dollars of savings for our customers.

Standardization is fundamental to our success. We identify a common market requirement and develop a standard product line or production process that meets those defined needs. Standardization lowers material, tooling and production costs and lays the foundation to produce specials more cost-effectively when they are required for your unique applications. We are a leader in the development of international industry standards.

Our production capabilities cover a wide range of modern processes spanning proprietary roll-forming technology, cold heading, metal cutting, laser beam machining and precision stamping. We develop our own precision tooling and perform most heat treating and finishing processes in-house to maximize our productivity and ensure consistent quality of our products.

In addition to a comprehensive line of engineered components used for joining and assembly, SPIROL also offers a full range of installation equipment designed to facilitate cost-effective and high quality assembly of your products. Our installation solutions range from manual machines to fully automated work cells with statistical process control and error-proofing options. We are the only company of our kind that offers the total integrated solution.

We put these specialties together at our Worldwide Technology Centres where we combine decades of application engineering experience with state-of-the-art production technology, certified inspection and test laboratories, insertion equipment and literally thousands of standard parts to provide optimized solutions – quickly.

Reasons you should partner with SPIROL:

- + Our core purpose is to be a resource that facilitates the reduction of your assembly costs, improves your product quality and enhances your overall competitiveness
- + Extensive application engineering experience and proven success will assist you in developing your products and get you to market quickly
- + A broad range of standard products and low-cost methods of producing your special requirements at competitive prices
- + Installation technology combined with application engineering expertise to deliver a complete solution
- + Outstanding operational service, responsiveness and product quality
- + Financial security and long-term stability
- + Bar coding
- + Special packaging options
- + Stocking programs
- + Part marking
- + Blanket orders
- + Logistics expertise
- + Global presence
- + Electronic data interchange (EDI)
- + Low minimums
- + No tool charges for standard parts
- + Product testing capability

SPIROL® Solutions

It is our application engineering experience that truly differentiates us. Through partnering with companies in the design stage, we not only help design the engineered fastener, but we also make the critical recommendations for the interface between our product and your assembly.



Coiled Spring Pins

SPIROL invented the Coiled Spring Pin in 1948. Easily recognized by its unique 2¼ coil cross-section, Coiled Pins are self-retaining pins that compress when installed into the host component. They are the only pins with uniform strength and flexibility after insertion. Truly an “engineered-fastener”, the Coiled Pin is available in three “duties” to enable the designer to choose the optimum combination of strength, flexibility and diameter to suit different host materials and application requirements. Their shock absorbing design dampens forces and vibration to prevent hole damage and prolong assembly life. Coiled Pins have square, burr-free ends and lower insertion forces than other pins, which make them ideal for automated assembly systems. The features of the Coiled Spring Pin make it the industry standard for applications where product quality and total manufacturing cost are critical considerations. Offered in diameters ranging from .031” (0.8mm) to .750” (20mm), SPIROL’s extensive standard range affords the designer the opportunity to incorporate a high performance pin which has low order minimums and off-the-shelf availability.

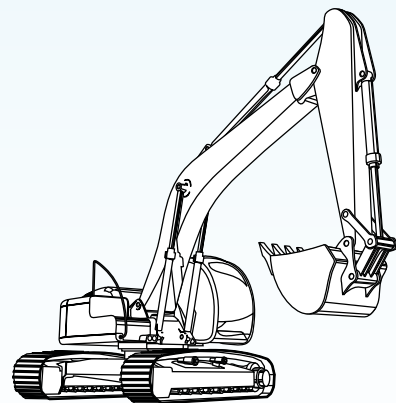

Application Engineering at Work

AGRICULTURE/HEAVY EQUIPMENT

Examples of applications: Backhoes, tractors, dump trucks, seeding equipment, tillage equipment, earthmoving equipment, tractor trailer components, freight car doors, cargo handling straps, fork lifts, hoists and cranes.

Markets served include

Aerospace | Agricultural/Heavy Equipment
Alternative/Green Technologies | Automotive | Cosmetics
Durable Consumer Products | Electronics | Government/Defence
Hand & Power Tools | Industrial Equipment | Integrators
Lawn & Garden | Locks & Latches | Medical
Pumps/Valves/Fluid Control | Recreational Vehicles
Window/Door Hardware



Slotted Spring Pins

Slotted Spring Pins are general purpose low cost components used in numerous fastening applications. The most appropriate applications for Slotted Pins are in non-critical assemblies manufactured out of mild to hardened steel that are manually assembled. Compressed as it is installed, the pin applies continuous pressure towards the sides of the hole wall. Unlike the Coiled Spring Pin, which radially compresses, the primary spring action of the Slotted Pin is focused on the area opposite the gap with the two halves of the pin compressing, or folding, toward the centre of the pin as it is installed. Like all Spring Pins, this allows the Slotted Pin to accommodate wider hole tolerances than rigid Solid Pins, which results in reduced manufacturing costs. SPIROL offers a comprehensive line of commercial (ASME and ISO) and military (MS/NASM and NAS) standard pins ranging in diameters from .062" (1.5mm) to .500" (12mm) in high carbon and stainless steels.



Solid Pins

Solid Pins are straight, cylindrical, relatively inflexible press-fit pins. Available with or without a head, they are commonly used to locate components in a fixed position, to maintain alignment, or to act as axles, pivots or hinges. SPIROL's Knurled and Barbed Pins have raised "ridges" that interact with the host material to retain the pin. SPIROL's Press-N-Lok™ Pin has opposing barbs on each end of the pin and is designed to permanently retain two plastic components to each other. Unlike Straight Pins and Ground Dowels that require extremely tight hole tolerances, SPIROL's Knurled Pins are designed to be used in standard drilled holes to minimize manufacturing costs. Using this approach, SPIROL's Solid Pins are commonly used to replace expensive machined pins. Cumbersome screws are often replaced with Knurled and Barbed Pins that offer better retention and improved assembly speeds. SPIROL's comprehensive standard Solid Pin line includes Straight Pins, Knurled Pins and Barbed Pins - with or without a head. Diameters range from .062" (1.5mm) up to .250" (6mm) as a standard, and up to .750" (19mm) upon request.



Rolled Tubular Components

SPIROL specializes in replacing costly machined and cold formed components with less expensive roll-formed product without sacrificing performance in the application. Tubular parts not only cost less, but they are often up to 50% lighter than their solid equivalents. SPIROL has proprietary manufacturing technology that enables the cost-effective production of special tubular products that meet the performance requirements of more expensive processes. Parts can be produced with diameters up to 1.500" (38mm) and lengths up to 6.500" (165mm). Configurations include round, oval and "C" shaped geometries. Special features include perforations, notches, chamfers, as well as open, chevron, interlocking, and dovetail seams. Due to the highly flexible production method, many unique parts can be formed without tooling charges at a much lower unit cost. SPIROL's Application Engineering department manages the conversions through technical reports, component drawings, specifications, and testing that supports the proposed roll-form design.

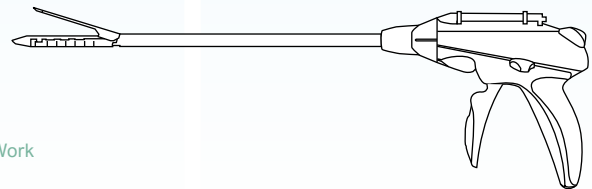

Application Engineering at Work

MEDICAL

Examples of applications: Surgical staplers, surgical shears, clamps, hand access ports, prosthetic implants, hearing aids, infusion pumps, monitors, defibrillators, x-ray machines, sterilizing devices, medical scales, hospital beds, wheelchairs, walkers, and blood pressure monitors.



Ground Hollow Dowels

SPIROL's Ground Hollow Dowels are designed to be a direct replacement for Ground Solid Dowels manufactured per ISO 8734 when used in alignment applications. This innovative product is manufactured from strip steel, and then OD ground to achieve extremely tight diameter tolerances that enable critical alignment up to 20µm. The main advantage of the Ground Hollow Dowel is its ability to achieve the same alignment as the Ground Solid Dowel with a significant reduction in cost. In most scenarios, the Ground Hollow Dowel is approximately 50% lighter and at least 30% less expensive than the solid equivalent. When required, the Dowels can be case hardened for wear resistance or manufactured from heat treated, high carbon steel for improved shear strength. This precision line of Ground Hollow Dowels is offered in five standard diameters: Ø6, Ø8, Ø10, Ø12 and Ø16mm. Depending on the application's requirements, specials can be developed and manufactured with minimal investment.

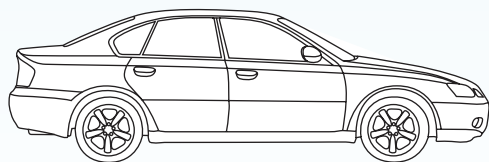

Application Engineering at Work

AUTOMOTIVE

Examples of applications: Transmissions, engines, shocks, braking systems, connecting rods, oil/water pumps, solenoid housings, starters, passenger assist handles, door handles, power outlets, glove box latches, door locks, window latches, sun visors, odometers, tilt steering columns, mirror detents, and oil sensors.



Dowel Bushings / Spring Dowels

SPIROL's Dowel Bushings and Spring Dowels are designed to maintain alignment and are used to locate components with respect to each other. These roll-formed, hollow Alignment Dowels have lead-in chamfers that facilitate insertion into the holes of both mating components. The flexibility of the Dowel enables absorption of wide hole tolerances and the staggered seam prevents interlocking. Dowel Bushings are designed with an inside diameter clearance that allows the passage of a bolt for fastening, thereby eliminating the need to drill additional holes. They are also heat treated to isolate the bolt from shear loads. Spring Dowels are designed around the holes in the mating components and are not used in conjunction with bolts. Dowel Bushings accommodate bolt sizes ranging from .250" to .625" and M5 to M16. Spring Dowels are designed for holes that range in diameter from M6 to M16 and available to order for holes ranging from .250" to .625". SPIROL's Dowel Bushings and Spring Dowels simplify assembly, reduce weight and significantly lower costs.

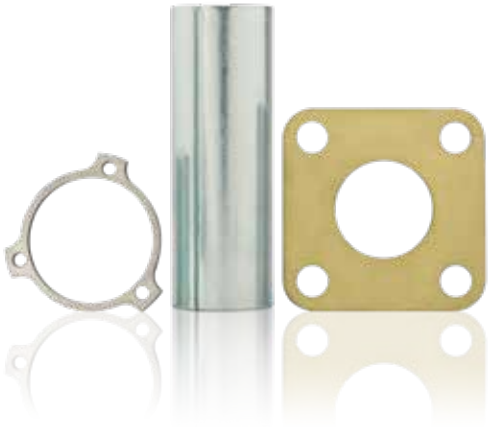

Spacers

SPIROL manufactures roll-formed, stamped, laser-cut and milled Spacers to accommodate a wide variety of application requirements. SPIROL's roll-formed Spacers are commonly used as stand-offs, distance bushings, sleeves, and axles. Typical applications consist of the Spacer separating two components in an assembly joined by a bolt, rivet or rod passed through the inside diameter of the component. The inside diameters of SPIROL's Spacers are designed for a clearance fit with a standard screw or bolt ranging in size from #4 (3mm) up to .750" in diameter (20mm). Standard diameters are available in any length without tooling charges, and each diameter is offered in standard and heavy wall configurations to address specific columnar strength and surface bearing requirements. Stamped, laser-cut and milled Spacers are available in thicknesses from .001" (0.02mm) to .750" (19mm) in any flat configuration. SPIROL's proprietary, highly flexible and efficient production technologies result in the ability to replace expensive cut-off tubing, tubes, ferrules, grommets and machined parts at a fraction of the cost.



Compression Limiters

Metal Compression Limiters enable designers to replace housings traditionally manufactured out of metal with plastic. Significant weight and cost savings can be realized, particularly with assemblies that have complex geometries. Metal Compression Limiters provide "spot" reinforcement of the plastic in high stress joints, or where components mate, enabling the main housing to be manufactured from lower cost plastic. SPIROL's Compression Limiter absorbs the load generated when a bolt is tightened to its recommended value. The plastic is isolated from excessive compressive loads ensuring that the joint remains intact throughout the life of the product. Compression Limiters have been designed for easy installation and provide excellent retention and anti-rotation. SPIROL offers a range of both roll formed and machined Compression Limiters including Split Seam, Molded-in, Oval and Solid Wall designs for bolts ranging in size from #4 (3mm) to 3/8" (12mm).



Inserts for Plastics

Inserts for Plastics allow designers to replace machined and cast metal components with plastic to achieve significant cost and weight savings without any loss of joint strength – even in demanding applications. The use of an Insert not only allows the appropriate installation torque to be applied to the screw without stripping the threads, but Inserts also ensure that the threaded joint integrity is preserved for the life of the application. In addition, SPIROL Inserts enable unlimited assembly and disassembly of the components without compromising the integrity of the threads. SPIROL carries a comprehensive line of Heat/Ultrasonic, Molded-In, Pressed-In and Self-Tapping Inserts allowing the designer to select a product specifically tailored to both the application's performance requirements and the preferred installation method. Offered in thread sizes ranging from 2-56 (M2) to 5/16-18 (M8). Special materials and larger thread sizes can be evaluated upon request.

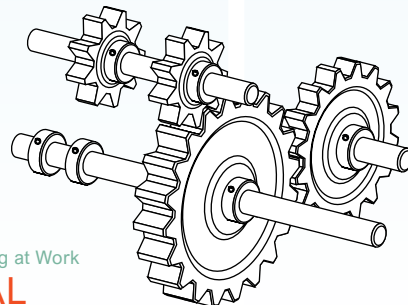

Application Engineering at Work

INDUSTRIAL

Examples of applications: Display racks, controllers, bottling & packaging equipment, pulp & paper manufacturing equipment, small engines, conveyors, material handling equipment, and various other manufacturing & handling equipment.

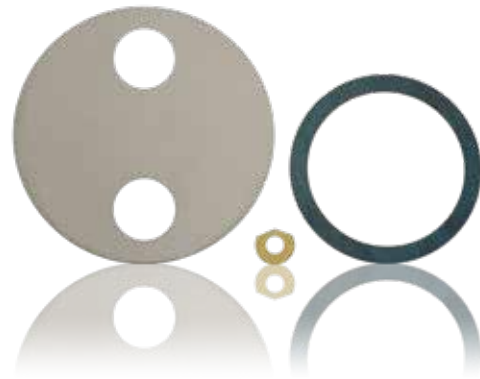

Precision Shims & Thin Metal Stampings

Precision Shims are used as compensators to absorb tolerances between mating components. They significantly reduce manufacturing costs as they eliminate the need for each component to be precision machined in order to achieve the proper fit and function of the total assembly. During the assembly process, Shims provide adjustment to compensate for accumulated tolerances. This significantly reduces machining and assembly time. Additionally, Shims are commonly used to preserve the faces between mating components, thus reducing the required machining time during rebuilding and retrofitting. SPIROL produces Shims with or without a tool to meet customer lead-time and total cost considerations. In addition, most secondary processes are performed entirely in-house affording complete control over lead-time and quality. Many secondary bundling and packaging options are available to facilitate ease of assembly considerations. The standard Shim product line includes Single Shims, Thin Spacers, Laminated and Edge-Bonded Shims custom-made to customer specifications from a comprehensive inventory of raw materials in thicknesses from .001" (0.02mm) to .750" (19mm).

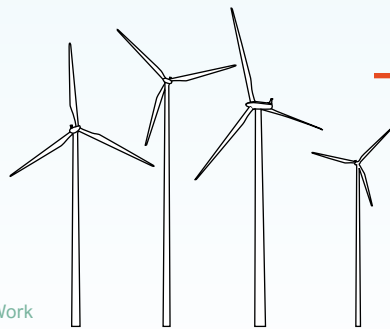

Application Engineering at Work

ALTERNATIVE/ GREEN TECHNOLOGIES

Examples of applications: Wind turbines, solar panels, solar powered devices, lithium ion batteries, hydrogen fuel cells, steam powered generators, hydro/wave powered assemblies, nuclear powered devices, and hybrid vehicles.

Precision Washers

SPIROL manufactures specialty Precision Washers to meet the requirements of unique applications. These engineered Washers are flat, metal disks with a hole in the middle that have a wide variety of uses. Washers lessen the possibility of damage to mating components and offer a flat space for a nut or bolt to be held securely in place. Other uses are to act as a spacer, wear pad, preload indicating device, or to prevent galvanic corrosion. SPIROL's Thrust Washers feature less wear and longer life for reduced serviceability costs in a variety of high-wear applications including heavy equipment, automotive, transmission, and industrial power generation. SPIROL has thousands of OD/ID tools on the shelf and a variety of manufacturing methods to minimize or eliminate tooling costs. Most secondary processes are performed in-house to guarantee quality, reduce lead times and lower cost. SPIROL produces specialty Washers that range in size from a minimum ID of $\text{\O}0.048$ " (1.2mm) to a maximum OD of $\text{\O}48$ " (1,220mm) in thicknesses from .001" (0.02mm) to .750" (19mm). SPIROL's Precision Washer product line includes Thrust Washers, Compression Rings, Piston Rings and Cylinder Rings.



Disc Springs

Disc Springs are conically-shaped components designed to be axially loaded. Due to their predictability, high reliability and unparalleled fatigue life, Disc Springs are preferred over all other types of springs in critical applications such as safety valves, clutch and brake mechanisms for elevators and heavy equipment, and supports for industrial pipe systems. They can be used individually or assembled into stacks to achieve the desired force-deflection characteristic required for the application. SPIROL Disc Springs' performance characteristics are predictable and the minimum life cycle can be calculated. They also provide high levels of load / force within a very small space unlike alternative spring-type components which require a significantly larger footprint to achieve the same load. SPIROL's expansive Disc Spring offering ranges from Ø8mm to Ø250mm with thicknesses up to 14mm. Standard materials include high carbon steel, alloy steel and stainless steel.

Feeding Technology

SPIROL's Series 2000 Vibratory Feed Systems provide higher feed rates, gentler feeding, and the ability to accommodate a wider range of part configurations and materials than conventional feed systems. The advanced state-of-the-art electronic controller combines modern technology and unique features to deliver superior performance by continuously and automatically adjusting the drive system to the natural frequency of the bowl. This variable frequency technology compensates for changes in the bowl mass to ensure consistent feed rates and eliminates bowl tuning, allowing interchangeable bowls with a single drive. Additional benefits include increased energy efficiency, clockwise/ counterclockwise capability, reverse rotation, and significantly lower noise levels. The controller utilizes a touch screen interface with the capacity to store 50 recipes.

Installation Technology

SPIROL offers a comprehensive line of installation equipment focused on improving the quality of the final assembly, eliminating scrap and reducing the total cost of the product. Ranging from manual to fully automatic, our equipment is designed to install Pins, Bushings, Compression Limiters, and Threaded Inserts. These robust, reliable, proven machines can be equipped with options such as pin sensing, part presence sensing, distance and force monitoring, indexing fixtures, full perimeter guarding and operator lock-out. These options provide error-proofing of your assembly process for heightened process control. SPIROL adapts our standard modules to customer-specific applications to enhance productivity. Custom fixturing and product nests ensure proper alignment and yield a quality installation. SPIROL guarantees that our equipment will enhance your productivity and reduce your total assembly costs by offering the only Performance Warranty in the industry.

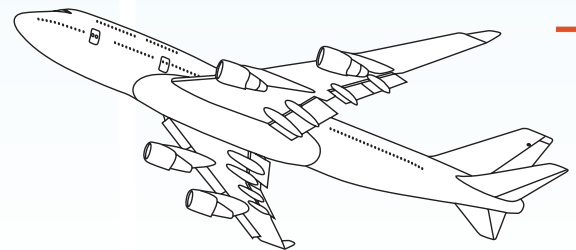

Application Engineering at Work

AEROSPACE

Examples of applications: Landing gear, airplane engines, luggage compartments, fuselage, folding trays, seats, seat belts, oxygen mask storage compartments, navigational equipment, ailerons, and other related airplane components and helicopter components.

Optimal Application Engineering

When you engage SPIROL as part of your team, we will utilize our 5-Step Process for Success to ensure that you receive an appropriate solution in a timely manner.

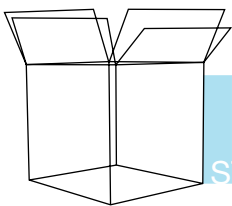

STEP **1**

We work with you to define your product performance, assembly and commercial objectives. This includes gathering sample components, the drawings of the individual components and the assembly-level drawings. At this stage, we also define commercial objectives such as target product costing, product packaging/labelling, and delivery requirements.

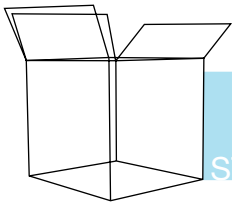

STEP **2**

After we gather your product, assembly and manufacturing objectives, we will conduct a comprehensive engineering evaluation. We have a group of Application Engineers who are dedicated to assisting you in determining the best solution for your particular application.

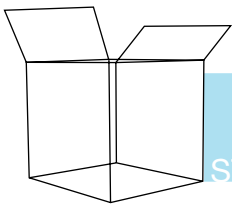

STEP **3**

We will provide you with a formal technical and commercial proposal, including prototypes for evaluation in your assembly. The proposal will detail other products that were considered for your application, and ultimately why the recommended part is the optimum solution.

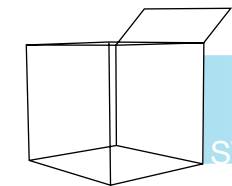

STEP **4**

If installation equipment is involved, we can also design a fixture to hold and align the components during insertion. We build, test, install and certify the machine – as well as educate your operators and maintenance personnel.

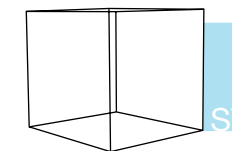

STEP **5**

We plan production to meet your delivery requirements and will ship certified products anywhere in the world – on time.

Locations

N. America

SPIROL International Corporation
30 Rock Avenue
Danielson, Connecticut 06239
United States
Tel. +1 (1) 860 774 8571
Fax. +1 (1) 860 774 2048
Email: info@spirol.com

SPIROL Shim Division
321 Remington Road
Stow, Ohio 44224
United States
Tel. +1 (1) 330 920 3655
Fax. +1 (1) 330 920 3659
Email: info@spirol.com

SPIROL Canada
3103 St. Etienne Boulevard
Windsor, Ontario
N8W 5B1 Canada
Tel. +1 (1) 519 974 3334
Fax. +1 (1) 519 974 6550
Email: info-ca@spirol.com

SPIROL Mexico
Avenida Avante #250
Parque Industrial Avante Apodaca
Apodaca, N.L. 66607 Mexico
Tel. +52 (01) 81 8385 4390
Fax. +52 (01) 81 8385 4391
Email: info-mx@spirol.com

S. America

SPIROL Brazil
Rua Mafalda Barnabé Soliane, 134
Comercial Vitória Martinin
Distrito Industrial
CEP 13347-610 Indaiatuba
São Paulo, Brazil
Tel. +55 19 3936 2701
Fax. +55 19 3936 7121
Email: info-br@spirol.com

Europe

SPIROL France
Cité de l'Automobile
ZAC Croix Blandin
18 Rue Léna Bernstein
51100 Reims, France
Tel. +33 (0) 3 26 36 31 42
Fax. +33 (0) 3 26 09 19 76
Email: info-fr@spirol.com

SPIROL United Kingdom
17 Princewood Road
Corby, Northants
NN17 4ET United Kingdom
Tel. +44 (0) 1536 444800
Fax. +44 (0) 1536 203415
Email: info-uk@spirol.com

SPIROL Germany
Ottostr. 4
80333 Munich, Germany
Tel. +49 (0) 89 4 111 905 71
Fax. +49 (0) 89 4 111 905 72
Email: info-de@spirol.com

SPIROL Spain
Plantes 3 i 4
Gran Via de Carles III, 84
08028 Barcelona, Spain
Tel. / Fax +34 932 71 64 28
Email: info-ib@spirol.com

SPIROL Czech Republic
Evropská 2588 / 33a
160 00 Prague 6-Dejvice
Czech Republic
Tel. + 420 226 218 935
Email: info-cz@spirol.com

SPIROL Poland
ul. Solec 38 lok. 10
00-394, Warszawa, Poland
Tel. +48 510 039 345
Email: info-pl@spirol.com

Asia/Pacific

SPIROL Asia Headquarters
1st Floor, Building 22, Plot D9,
District D, No. 122 HeDan Road
Wai Gao Qiao Free Trade Zone
Shanghai, China 200131
Tel. +86 (0) 21 5046 1451
Fax. +86 (0) 21 5046 1540
Email: info-cn@spirol.com

SPIROL Korea
16th Floor, 396 Seocho-daero
Seocho-gu, Seoul, 06619
South Korea
Tel. +82 (0) 10 9429 1451
Email: info-kr@spirol.com

SPIROL Japan
Kyoto, Japan
Email: info-jp@spirol.com

Quality Certifications

Demonstrating our commitment to quality,
SPIROL has acquired the following quality certifications:

- + IATF 16949
- + ISO 9001
- + ISO 14001
- + Ford Q1
- + AS 9100
- + Nadcap AC7108
Chemical Processing
- + Nadcap AC7116/4
Nonconventional Machining
- + Caterpillar MQ11005
SQEP Certified



SPIROL.ca