

# SPIROL<sup>®</sup>

COILED SPRING PINS





**PROVIDING INNOVATIVE SOLUTIONS FOR FASTENING AND JOINING SINCE 1948!**

Starting with the invention of the Coiled Spring Pin, **SPIROL** stands apart from all other companies in our industry. We are a technical resource that provides high quality components that improve the quality of your assembly, extend the life of your products and reduce your manufacturing costs.

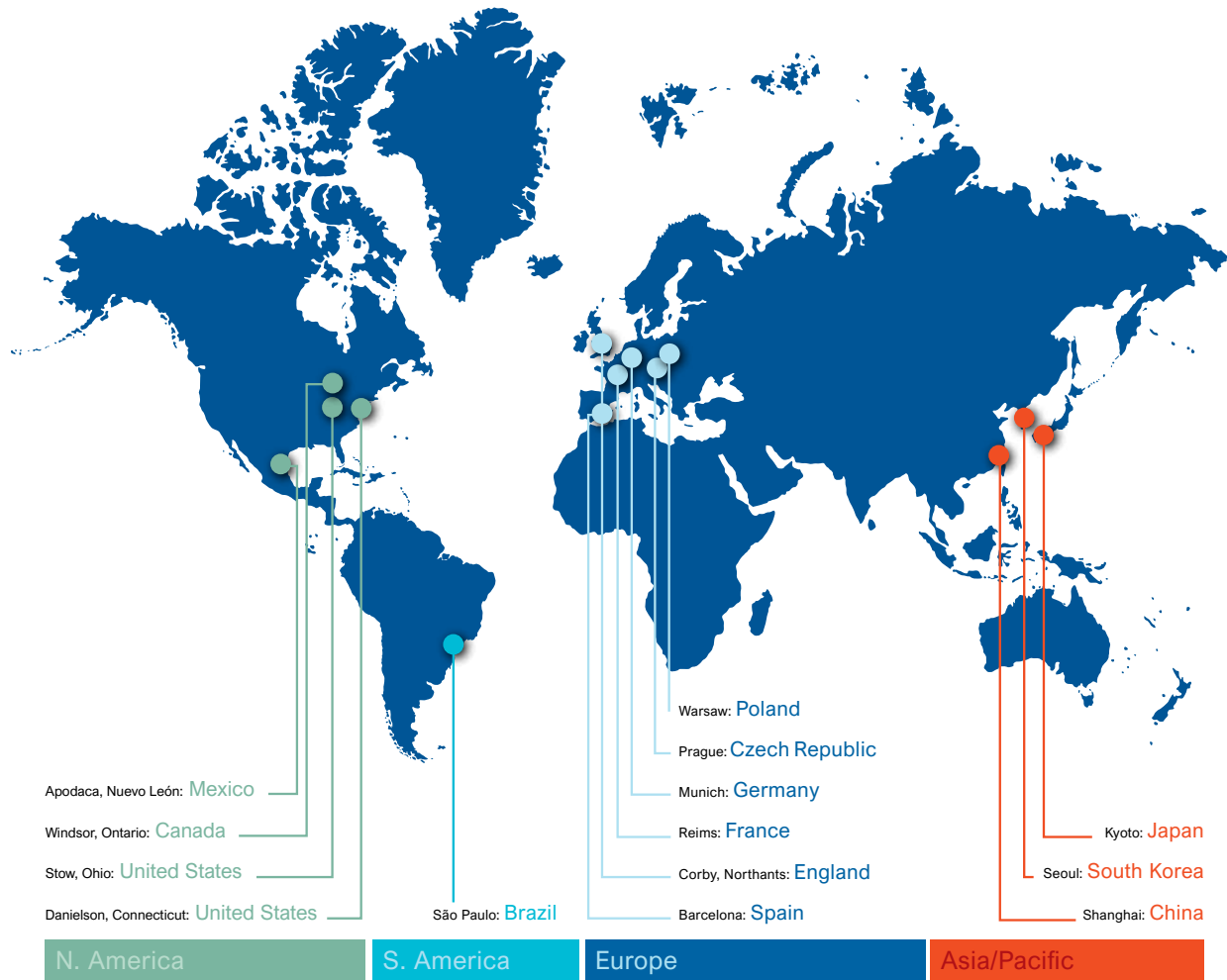

### Local Design, Global Supply

SPIROL has Application Engineers throughout the world to assist you in your designs, supported by state-of-the-art manufacturing centers and worldwide stocking facilities to simplify the logistics of delivering your product.

**Contact SPIROL for design assistance:  
[www.SPIROL.ca](http://www.SPIROL.ca)**



**SPIROL** invented the Coiled Spring Pin in 1948. This engineered product was specifically designed to address deficiencies associated with conventional methods of fastening such as threaded fasteners, rivets and other types of pins subject to lateral forces. Easily recognized by its unique 2¼ coil cross section, Coiled Pins are retained by radial tension when installed into the host component, and they are the only pins with uniform strength and flexibility after insertion.

Truly an “engineered-fastener”, the Coiled Pin is available in three “duties” to enable the designer to choose the optimum combination of strength, flexibility and diameter to suit different host materials and application requirements. The Coiled Pin distributes static and dynamic loads equally throughout its cross section without a specific point of stress concentration. Further, its flexibility and shear strength are unaffected by the direction of the applied load, and therefore, the pin does not require orientation in the hole during assembly to maximize performance.

In dynamic assemblies, impact loading and wear often lead to failure. Coiled Pins are designed to remain flexible after installation and are an active component within the assembly. The Coiled Pin’s ability to dampen shock/impact loads and vibration prevents hole damage and ultimately prolongs the useful life of an assembly.

SPIROL’s Coiled Pin was designed with assembly in mind. Compared to other pins, their square ends, concentric chamfers and lower insertion forces make them ideal for automated assembly systems. The features of the Coiled Spring Pin make it the industry standard for applications where product quality and total manufacturing cost are critical considerations.

This combination of features enables SPIROL Coiled Pins to improve the quality of your assembly, extend the life of your product and reduce your total manufacturing costs.

SPIROL’s extensive standard range affords the designer the opportunity to incorporate a high performance pin that has low order minimums and off-the-shelf availability.



### Three Duties

Flexibility, strength, and diameter must be in the proper relationship to each other and to the host material to maximize the unique features of SPIROL’s Coiled Pin. A pin too stiff for the applied load would not flex, causing damage to the hole. A pin too flexible would be subject to premature fatigue. Essentially, balanced strength and flexibility must be combined with a large enough pin diameter to withstand the applied loads without damaging the hole. That is why SPIROL Coiled Pins are designed in three duties; to provide a variety of combinations of strength, flexibility and diameter to suit different host materials and applications.

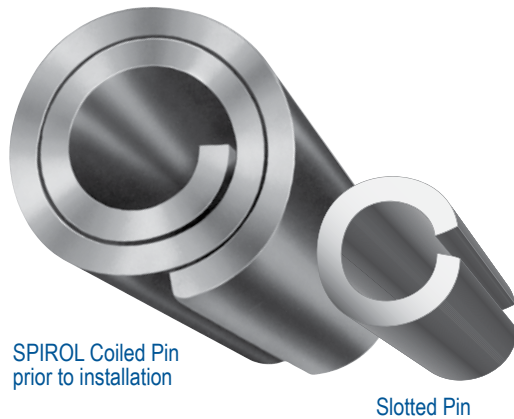

### Prior to Installation

All Spring Pins have the common characteristic of a pin diameter larger than the hole diameter into which the pin is installed. Coiled Pins can be easily identified by the 2 1/4 coil cross-section. The absence of a slot eliminates pin nesting and interlocking.

### Flexibility During Installation

When **SPIROL** Coiled Pins are installed, the compression starts at the outer edge and moves through the coils toward the center. SPIROL Coiled Pins spread compressive stress over the entire pin and do not have stress point concentrations.

Comparatively, Slotted Pins compress by closing the slot, and stress is concentrated 180 degrees opposite the slot. This imbedded stress at installation, combined with the concentration of stress during the assembly's life reduces the fatigue life of the Slotted Pin potentially causing premature assembly failure.

Solid Pins are retained by compressing and deforming the host material, not the pin. If the Solid Pin has knurls, the knurls cut into the host material during installation. In all instances, the Solid Pin must be harder than the host material or else the pin will be deformed.

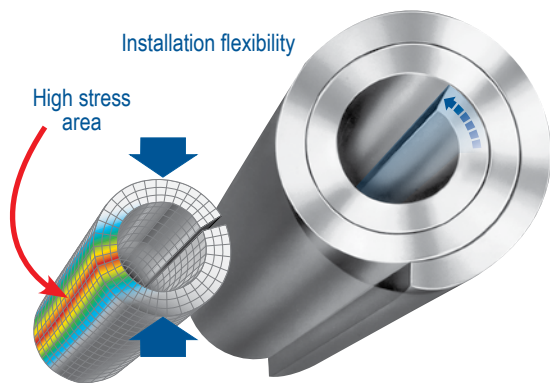

### Flexibility Under Applied Loads

The SPIROL Coiled Pin continues to flex and coil toward the center, absorbing shock and vibration, distributing the load equally throughout the cross section. Due to the fact that the material is able to coil over each other, load continues to be absorbed by the pin under a wide variety of situations.

Slotted Pins cannot flex after the slot is closed and load stresses are transferred to the assembly at this point rather than being absorbed by the pin. This often results in hole damage.

Similarly, due to their inflexibility, Solid Pins often damage the holes when used in dynamic loading applications. This leads to premature failure. Additionally, using a softer Solid Pin material reduces host damage, but commensurately reduces the pin's strength.

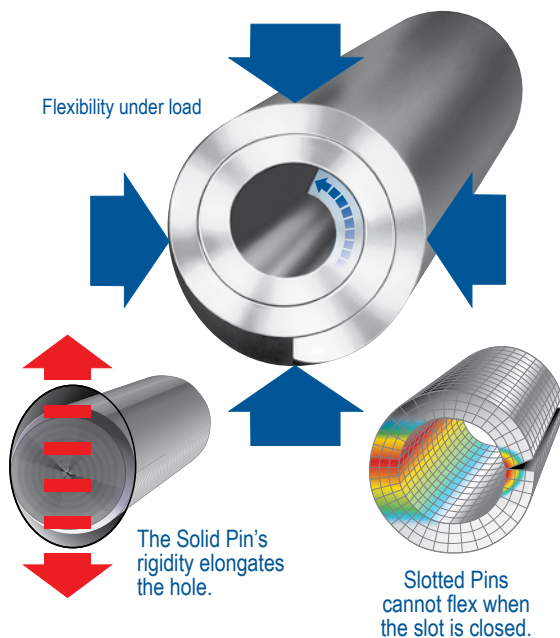

The primary elements affecting the total cost of the assembly are:

- 1) the cost of the individual components
- 2) the cost to assemble the individual components

To achieve optimal low cost designs, Design Engineers must consider not only the product design, but the entire assembly process. While the fasteners are typically the least expensive components within the assembly, they can have a profound impact on the total cost of the mechanism if not chosen properly. Designers should consider investing in a pin that improves the robustness of the overall product design, reduces the preparation cost of the individual components and simplifies the assembly process to ensure the overall cost of the assembly is minimized. Engineers should give early consideration during the design stage to ensure that the individual components of the assembly are designed appropriately for pin fastening. When total in-place and assembled costs are considered, **SPIROL** Coiled Pins are the pin of choice.

### Reduced Component Cost

SPIROL Coiled Pins can accommodate wide hole tolerances. In most assemblies, Coiled Pins can be used in holes that have simply been drilled rather than prepared with an expensive reaming, tapping, counterboring or staking operation. Stamped, fine blanked, cast, sintered, or laminate assemblies are all suitable hosts when using Coiled Pins. Controlled radial tension coupled with the ability to absorb shock permits the reduction of bulk and weight of components. In addition, lighter, faster machining and less costly component materials may be considered. This translates to lower total manufacturing costs of the host components.

### Reduced Assembly Cost

SPIROL Coiled Pins are the easiest type of pin to install. They can be installed simply with a hammer or by commercially available press technology. After installation, they are self-retaining within the hole. Consequently, the pin is installed in a single operation eliminating costly secondary operations of multi-part components such as a nuts and bolts or clevis pin and retaining rings, or multi-process products such as rivets or cotter pins. The Coiled Pin is also conducive for automating so assembly and the associated labor time and costs are minimized.

### Reduced Installation Cost

SPIROL Coiled Pins have low uniform insertion pressure, square ends, smooth chamfers and do not interlock. The benefit of these technical features is fast and efficient installation with fewer rejects and less equipment down-time.

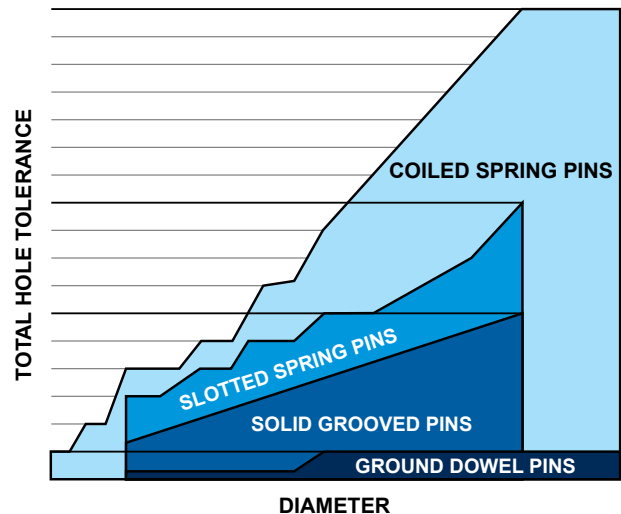

Coiled Spring Pins absorb the widest hole tolerances.

Only Coiled Pins utilize the coiled spring concept; a recognized superior pin design. This imparts to **SPIROL** Coiled Pins unique features not found in other Spring Pins or Solid Pins. More than fasteners, SPIROL Coiled Pins are also shock absorbing elements which are integral, active components of a total assembly. There are other pinning methods, but when the total assembly's manufacturing cost, quality and useful life are important, the pin of choice is the SPIROL Coiled Pin.

### Absorbs Shock and Vibration

The SPIROL Coiled Pin design represents broad design latitude in the control and development of pin flexibility. The engineered flexibility of SPIROL Coiled Pins provides for compression of the pin into the hole and for continued flexibility after insertion. Without this flexibility, the total load applied to the pin would be transmitted to the hole wall without dampening the impact. Since the host material is normally softer than the pin, elongation or enlargement of the hole would result. The fit between the hole and the pin would become loose, increasing the impact force and accelerating the rate of hole damage. The inevitable result would be premature failure of the assembly. In properly engineered applications, the flexibility of SPIROL Coiled Pins dampens shock and vibration, thus eliminating hole damage to all the components of the assembly resulting in maximum product life.

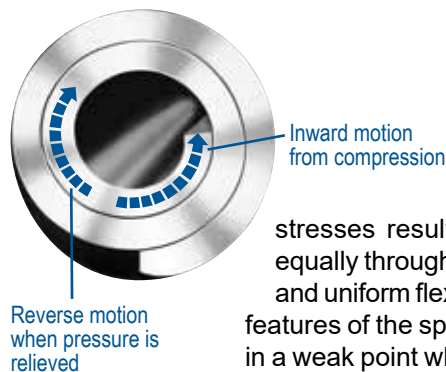

Reverse motion when pressure is relieved

### Uniform Strength and Flexibility

The shear strength and flexibility of SPIROL's Coiled Pin is not affected by the direction of force. Compression causes the pin to coil from the outer edge inwardly towards the center. As the pressure is relieved, which happens in shock and vibration, the pin action reverses thereby maintaining a constant radial force. Application of an excessive load results in compression into a solid tube. Further loading causes shear failure. In properly engineered applications, this condition should not occur.

### Equal Stress Distribution

Stresses imparted to the pin during installation compression as well as stresses resulting from applied loads are distributed equally throughout the pin's cross section. This concept and uniform flexing and strength are related and inherent features of the spiral design. Stress concentration results in a weak point where progressive shear failure starts and premature fatigue occurs. SPIROL Coiled Pins have no weak points.

### Swaged Chamfers

SPIROL Coiled Pins have a smooth, concentric lead-in chamfer with a radius which blends into the diameter of the pin. There are no sharp angles or edges to bite into the hole wall. The swaged chamfer provides maximum compression leverage with minimum thrust resistance to ease insertion. The chamfer concentricity assists in alignment of holes.

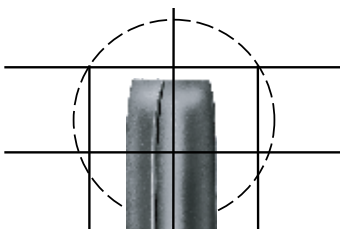

The smooth, concentric chamfer combined with square, clean-cut ends translates into trouble-free installation.

### Square Ends

SPIROL Coiled Pins have clean, square cut ends. This has a substantial impact on trouble-free automatic installation as the square ends enable the pin to align itself with the installation punch/quill to ensure the pin remains straight as it is inserted into the hole. The clean-cut ends also impart a quality image to the assembly.

### Closer Diameter Tolerances

**SPIROL** Coiled Pins have a closer diameter tolerance than any other Spring Pin. At least 270° of the outer circumference is within the specified tolerance range. The minimum diameter is not averaged, as is the case with other Spring Pins. The edge of the seam is designed to be tucked below the hole diameter to prevent the edge from contacting the host. These factors combine to make SPIROL Coiled Pins ideal for hinge, axle, and dowel applications.

### Lower Insertion Pressure – Radial Tension

Standard and light duty SPIROL Coiled Pins require less pressure to insert than other Spring Pins. In addition, these pins exert less radial tension, an important factor where holes are in thin sections or close to an edge. It is also important when using soft, weak or brittle materials such as aluminum or plastic. The benefit is lower component damage and fewer rejects. An added benefit to lower insertion force is insertion machinery can use smaller cylinders, and if manually installed, the assembler is less subject to fatigue or repetitive motion syndrome.

### Wider Hole Tolerance Range

SPIROL Coiled Pins can be installed in holes with a wide diameter tolerance. Holes can be drilled according to normal shop practices, drills can be used longer, and the feed rate of the drills can be maximized. Drilling can be eliminated completely by utilizing molded, cast, and stamped holes. No secondary hole preparation is necessary to be able to use a Coiled Pin.

### Straightness

Although the straightness specifications are technically the same, carbon steel Coiled Pins of longer length in relationship to diameter are straighter than roll-formed Slotted Pins. The stresses imparted during the heat treating process distort long Slotted Pins into a "banana shape" caused by the material stretching at the slot and contracting 180° opposite the slot. Straightness is important in numerous applications and for trouble-free insertion.

### Conforms to Hole

The thin gauge material and the 2¼ coiled construction gives the pin a greater inherent ability to conform itself radially and longitudinally to the hole wall.

It can be used in out-of-round and tapered holes without negatively affecting its performance. SPIROL Coiled Pins develop a mean radial pressure without excessive high points which would result in hole damage upon insertion or under loading. Other types of Spring Pins typically have three points of contact between the pin and the hole which results in focused stress over a limited contact surface area. On the contrary,

SPIROL Coiled Pins maximize contact between the pin and the hole resulting in better load distribution and reduced possibility of hole damage.

### Wider Range of Duties, Diameters and Materials

SPIROL Coiled Pins are offered in more duties, materials and smaller diameters than other Spring Pins. The Coiled Pin is available in three duties so that the pin may be tailored to the host material and application requirements. A wide variety of standard materials and finishes provide the necessary strength, corrosion resistance, fatigue life, and appearance to suit any need. The superior spring design also permits the use of non-heat treatable materials, such as austenitic stainless steel, while continuing to maintain spring characteristics.

### Automatic Feeding

The square ends and the absence of slots have a substantial impact on trouble-free automatic feeding. Of most importance is the absence of a slot which eliminates pin nesting and interlocking—a major problem in automation.



Example of interlocked Slotted Pins.

### Reusable

When driven from a hole, the SPIROL Coiled Pin expands towards its original diameter. The same pin may be reused in the same hole.

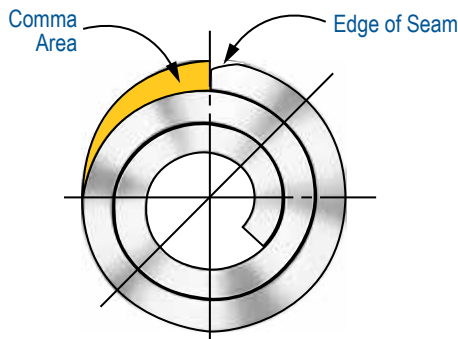

The edge of the seam is designed to be tucked down and away from the hole diameter.

**SPIROL** Coiled Spring Pins are often used in applications traditionally assembled with Solid Pins. There is a common misconception that “Solid Pins are always stronger than Coiled Pins”. The fact is, the majority of the applications use low carbon steel Solid Pins and for those that use Coiled Pins, the most common is a heat treated high carbon steel, standard duty Coiled Pin. When comparing the strength of low carbon steel Solid Pins to the strength of high carbon steel, standard duty Coiled Pins, the Coiled Pins are stronger due to the fact that the material is heat treated. Heat treating imparts strength and flexibility to the Coiled Pin, and results in the Coiled Pin being over 15% (on average) stronger than Solid Pins (*Table 1*).

One of the primary advantages of a Coiled Pin over a Solid Pin is that a Coiled Pin can be tailored to the application to balance its strength and flexibility. Proper designs will ensure that the Coiled Pin is strong enough to resist the forces generated during use of the assembly, and that the

pin is flexible enough to prevent any damage to the hole. The net result is the prolonged useful life of the assembly. This is not possible with Solid Pins due to their rigidity.

PIN DIAMETER	LOW CARBON STEEL GROOVED PINS	HIGH CARBON STEEL COILED PINS	% STRONGER THAN SOLID PINS
	DOUBLE SHEAR STRENGTH IN kN		
1.5	1.2	1.45	+20.8
2	2.2	2.5	+13.6
2.5	3.5	3.9	+11.4
3	5	5.5	+10.0
4	8.8	9.6	+9.1
5	13.8	15	+8.7
6	19.9	22	+10.5
8	31.2	39	+25.0
10	48.7	62	+27.3
12	70.2	89	+26.8

Table 1: Strength of standard duty Coiled Pins compared to Solid Pins

### What is shear strength?

In short, the shear strength of a pin is determined by the maximum amount of force the pin can withstand before it breaks when the force is applied perpendicular to the axis of the pin. Pins can be sheared in multiple planes, for example, a pin that breaks in single shear would result in two separate pieces of the pin, whereas a pin that breaks in double shear would result in three separate pieces of the pin.

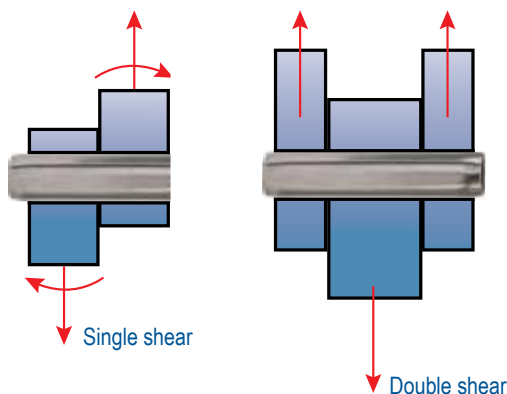

The shear values listed on pages 14-19 will only be obtained when tested in accordance with the applicable ASME or ISO procedures noted on each page. If the application conditions differ, strength compensations must be made and actual tests should be performed to verify design.

While there are subtle differences between the shear specifications, there are many overlapping elements.

Per ISO 8749 — The shear test is performed in a fixture in which the pin support members and the member for applying the load have holes with diameters conforming to the nominal pin size and a hardness of not less than 700 HV. (*A typical fixture is shown below.*) The clearance between the supporting member and the load member shall not exceed 0.15mm (.005”). The shear planes shall be at least one pin diameter away from each end and at least two diameters apart. Pins too short to be tested by double shear shall be tested by shearing two pins simultaneously in single shear. Pins shall be tested to fracture. The maximum load applied to the pin coincident with or prior to pin fracture shall be regarded as the double shear strength of the pin. Pins tested for shear strength shall show a ductile shear without longitudinal cracks. The speed of testing shall not exceed 13mm/min. (.5”/min.).

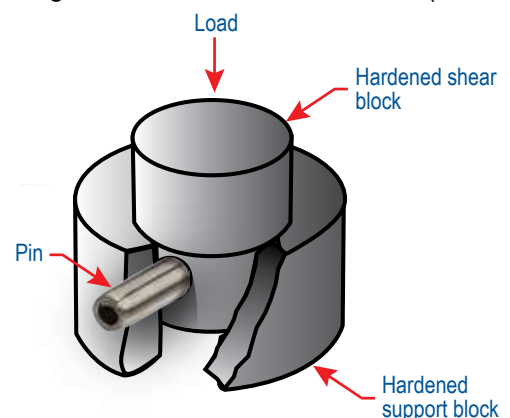

Shear test performed in a fixture per ISO 8749



### Technical Data – Shear Strength and Dynamic Considerations

**SPIROL** Coiled Pins are designed to withstand shock and rapidly changing oscillating or intermittent dynamic forces. Dynamic forces should be calculated in accordance with accepted engineering principles, and a pin should be selected with a static shear strength which exceeds the calculated dynamic forces. Whenever it is impossible to calculate the theoretical dynamic forces, it becomes necessary to determine the static load to which the joint is to be subjected. Depending on the severity of the shock and vibration, an adequate safety factor must be applied. Minor dynamic forces can usually be disregarded.

Due to the many factors which are involved in a dynamic situation, it is impossible to precisely define test conditions which would provide data that could readily be applied to an actual application. Therefore, for all new designs, SPIROL recommends that life cycle testing of the actual assembly be conducted under simulated real world conditions to ensure the pin meets the desired performance requirements. The simulation should not be accelerated to the extent that a new dynamic situation is created. A properly performing pin will eventually fail without damaging the hole, but only after the design life of the assembly has been achieved.

Dynamic failure does not occur in the shear plane. It is not a straight cut, but rather a helical failure. As a result, the pin may continue to function even after failure and be discovered only during disassembly.

Independent studies<sup>1</sup> have resulted in the following findings:

- Unlike static shear, where fracture always occurs in the shear plane, in dynamic failure of Coiled Spring Pins, the fracture occurs some distance from the shear plane. This testifies to the pin's flexibility. In addition, the fracture in Coiled Pins progresses helically from the outer coil so the pin continues to function after initial fracture.
- Dynamic endurance decreases as the length of a Spring Pin increases in relation to the diameter. This decrease is less for SPIROL Coiled Pins than for other Spring Pins.
- In all tests, Coiled Pins outlasted Slotted Pins. In some instances where other pins failed at less than 100,000 cycles, properly designed Coiled Pins had an infinite endurance life at the same load (as shown below).

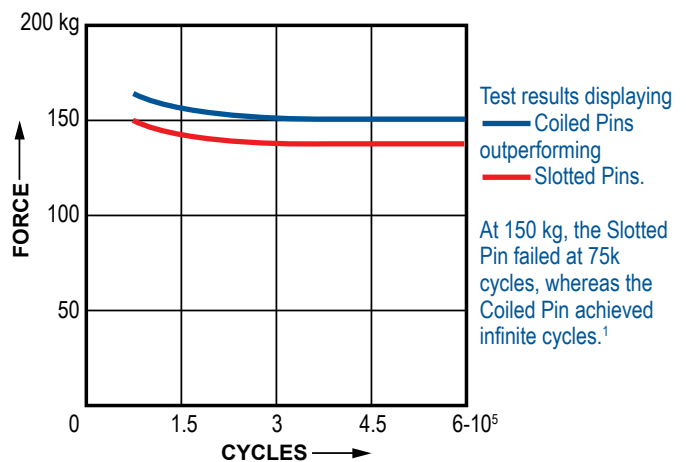

### Choosing the Proper Pin Diameter and Duty

It is important to start with the load to which the pin will be subjected. Then evaluate the material of the host to determine the duty of the Coiled Pin. The pin diameter to transmit this load in the proper duty can then be determined from the shear strength tables (on pages 14-19) taking into consideration these further guidelines:

- Wherever space permits, use standard duty pins. This pin has the optimum combination of strength and flexibility for use in nonferrous and mild steel components. It is also recommended in hardened components because of its greater shock absorbing qualities.
- Heavy duty pins should be used in hardened materials where space or design limitations rule out a larger diameter standard duty pin.
- Light duty pins are recommended for soft, brittle or thin materials and where holes are close to an edge. In situations not subjected to significant loads, light duty pins are often used because of easy installation resulting from lower insertion force.

<sup>1</sup> • ASME Paper No. 58-SA-23 by Dr. M.J. Schilhasl  
 • Konstruktion 1960, Issue 1: Pages 5-13; Issue 2: Pages 83-85  
 both by Prof. Dr.-Ing K. Lürenbaum

### Locating and Alignment Design

To achieve optimal alignment when using Coiled Pins, two primary design elements must be adhered to:

- 1) The hole diameters in the host and mating component must be correctly sized to achieve the desired interference and accuracy of alignment.
- 2) In all applications, the engagement length of the Coiled Pin in the component providing primary retention must be no less than 60% of the pin's overall length. The remaining protruding length will align with the mating component. Increasing the initial length of engagement is recommended in thru-hole applications; however, the Coiled Pin still has to protrude in order to align the mating component.

#### Interference fit for maximum alignment accuracy:

Coiled Pins are functional springs that conform to the holes into which they are installed. The assembly force to achieve maximum accuracy in alignment should not exceed a 'light' press to seat mating components. Depending upon Coiled Pin duty, quantity of alignment pins, and host material, this may be as little as a tap with the palm of a hand or a mallet. An interference fit must not be confused with that of a traditional Solid Dowel which typically requires seating with pneumatic or hydraulic presses. This is a primary benefit of the Coiled Pin.

To ensure a light press fit, ideally, the hole size in both the host and mating components should be precision matched within the recommended tolerance range. This may not be practical if holes are not drilled together as an assembly.

In situations where holes cannot be precision matched or where the cost of honing/reaming is prohibitive, a significant benefit of the Coiled Pin is its ability to compensate for larger hole tolerances. The recommended tolerance range may be divided between components as demonstrated below. *(Note: Utilizing less of the allowable manufacturing tolerance will further improve the fit and alignment of the assembly.)*

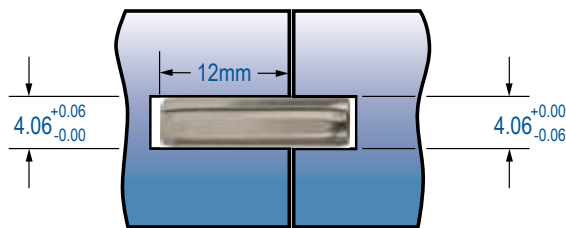

Recommended hole size and pin depth for CLDP 4 x 20 LBK

Assigning the larger tolerance to the 60% retention location ensures interference between the free end of the pin and the opposing hole that is prepared at the lower half of the tolerance. Where there is interference there is no clearance, thus ensuring proper projection of the primary hole's position.

#### Clearance fit for course alignment and ease of assembly:

If a clearance fit over the pin is desired for ease of assembly, it will be necessary to compensate for spring recovery at the pin's free end. To determine the maximum diameter of the free end of the pin, install the pin to 60% of the pin's length into the maximum hole size of the primary retention host and measure the exposed diameter. A 0.025mm (.001") to 0.05mm (.002") clearance factor should be added to the free end of the pin depending upon desired alignment accuracy.

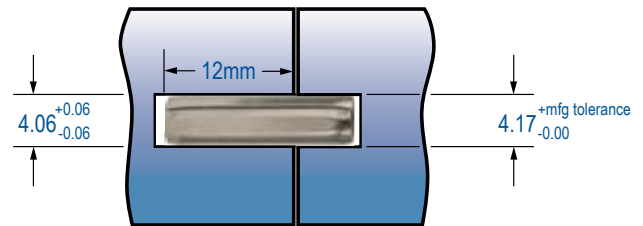

Recommended hole size for clearance fit with CLDP 4 x 20 LBK

When used as a free fit alignment dowel, assembly force is not a consideration; although it is important to note that consideration should be given to using the Coiled Pin as an interference fit solution. As outlined above, Coiled Pins provide the benefit of a zero clearance fit without the added complexity of high insertion force.

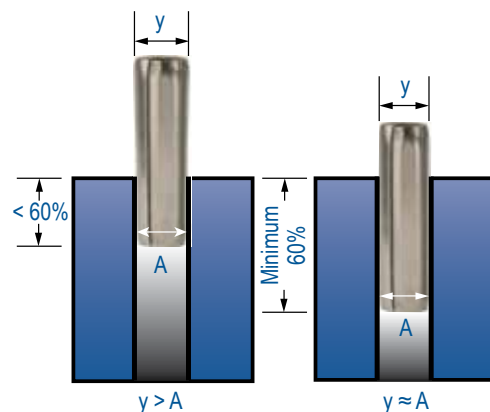

This diagram demonstrates proper installation depth. When a Coiled Pin is installed less than 60% of its overall length two conditions may occur:

- (y) or the free end diameter will not be properly controlled creating inconsistent 'fit' when parts are mated downstream in the production process.
- The pin may not maintain position in the component in which it is intended to be retained during future disassembly. This is of greatest importance when multiple alignment pins are utilized between components.

### Shaft Design

One of the primary benefits of using a Coiled Pin to affix a collar or hub to a shaft is the Coiled Pin's ability to prevent hole damage. There are a few design guidelines that must be adhered to in order to achieve the maximum strength of the pinned system and prevent damage to the shaft and/or hub:

**Shaft** – The hole in a shaft should not exceed 1/3 of the shaft diameter. For mild steel and nonferrous shafts, standard duty pins are recommended. The extra strength of a heavy duty pin is only beneficial if the hole is less than 1/4 the diameter of the shaft or if the shaft is hardened.

**Hub** – **SPIROL** recommends that the hub be designed with a minimum wall thickness of 1.5 times the diameter of the pin. Otherwise, the strength of the hub will not match the shear strength of the pin. As the wall thickness of the hub increases, so does the area of material around the pin to absorb the load.

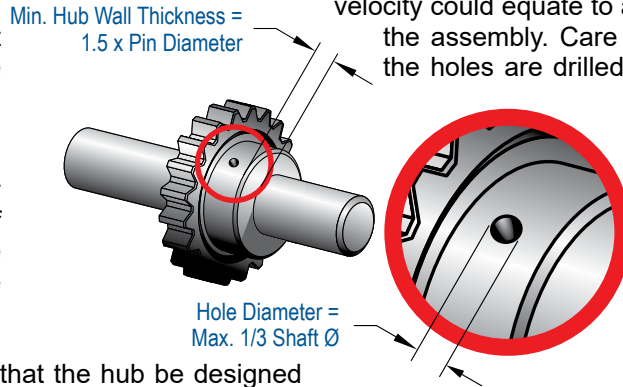

**Shaft and Hub** – The diameter of the holes through both the shaft and hub should be precision matched to eliminate any movement of the pin within the holes. It is recommended that the difference between the holes not exceed 0.05mm (.002”). Otherwise, the pin will be subject to dynamic loading where a very small change in velocity could equate to an enormous change in force on the assembly. Care should be taken to ensure that the holes are drilled through the center of the shaft and the hub.

The outer diameter (OD) of the shaft and the inner diameter (ID) of the hub should be designed such that the distance between the shear planes (OD - ID) does not exceed 0.15mm (.005”). In addition, countersinks, particularly on the hole in the shaft, are not recommended. Otherwise, the pin will be placed in bending and the maximum strength of the pinned system will not be achieved. This could lead to premature failure of the assembly.

### Hole Design

It is important to note that the **recommended hole sizes** (on pages 14-19) may not be true for all applications. There are many applications that require a different hole size to ensure the proper function of the assembly. For this reason, it is recommended that **SPIROL** be consulted on new designs.

Even though the Coiled Pin absorbs wide hole tolerances, holding tighter tolerances, particularly in some applications such as friction fit hinges, precision alignment and shaft and gear assemblies will result in better performance.

In all cases, care must be taken to have enough material around the pin to prevent bulging and deformation of the host material. In most applications, the applied loads will far exceed the hoop stresses exerted by the Coiled Pin. Never specify a non-heat-treated Coiled Pin for use in a hardened hole.

In the case of hardened host materials with drilled holes, the edges of the hole should be deburred. A countersink does not eliminate the sharp edge of a hardened hole, and rather displaces the sharp edge to the transition

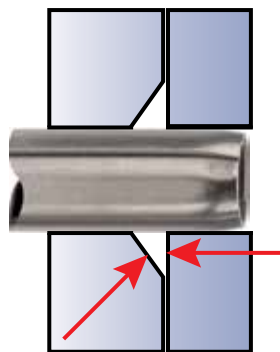

between the countersink and entrance to the hole. Furthermore, countersinks increase the distance between the shear planes which can put the pin in bending and thus reduce its strength (as shown at left). Cast or sintered holes should be provided with a slight lead-in radius.

In punched or pierced holes, it is recommended that pins be inserted in the same direction as the punch to prevent any residual burr from impacting the pin during installation.

A countersink increases the distance between the shear planes. This can put the pin in bending and thus reduce the strength of the pin.

**Permissible Hole Misalignment** – Coiled Pins are capable of compensating for minor misalignment as they are manufactured with a generous lead-in chamfer. In order to determine the maximum misalignment

between mating holes into which the Coiled Pin is installed, use the following calculation:

$$MPHM = \frac{1}{2} (H-B) \text{ where;}$$

- MPHM = Maximum Permissible Hole Misalignment
- H = Minimum hole diameter of the second hole through which the pin will be inserted
- B = Chamfer diameter (assume this to be equal the “B Max” dimension listed on pages 14-19)

### Hinge Design

There are two primary types of hinges:

- 1) A **free fit hinge** has little to no friction or drag when the latch or handle is rotated. Hinge components are “free” to rotate independent of one another.
- 2) A **friction fit hinge** requires interference to prevent free rotation of components relative to one another. Depending on design intent, resistance can vary from a slight drag to a value sufficient to maintain the fixed position of components anywhere in their full range of rotation.

Coiled Spring Pins are particularly well suited for use in both friction and free fit hinges. To achieve optimum long-term hinge performance designers should observe some basic design guidelines. Regardless which pin type is used, the gap between hinged components should be minimized to reduce clearance and avoid bending of the pin.

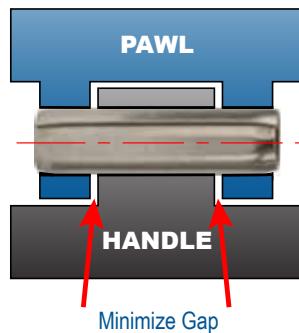

#### FREE FIT HINGE

If a **free fit hinge** is desired, the Coiled Pin’s pre-installed diameter is of negligible importance as pin diameter is determined by the retaining, or smallest hole(s). Coiled Pins are functional springs and recovery & retention in free fit locations must be considered. The amount of recovery/retention is dependant upon the diameter of the tight (retaining) hole(s) and the ‘free span’ of the pin. Free span would be defined as the distance a pin passes through a free fit component. As free span increases, the pin diameter will also increase as it “recovers” a portion of its pre-installed diameter.

It is recommended for better load distribution and closer tolerance hinges that the tight fit of the Coiled Pin be in the outer members of the hinge. The minimum thickness of the outer members should be equal to the diameter of the pin. If the thickness of the outer members are less than the diameter of the pin, then the tight fit should be in the inside hole.

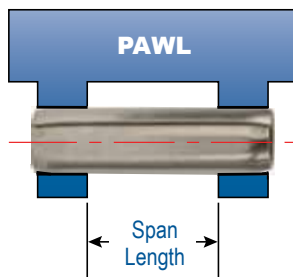

To design a free fit hinge, first establish the maximum hole size in the retaining component (tight fit). Insert the Coiled Pin into the retaining component and measure the free diameter of the pin at the center of the span. Add a factor to provide some clearance for the rotating member, usually 0.02mm (.001”) to establish the minimum diameter of the free hole. Then add the required production tolerance to assign the maximum diameter of the free hole.

If the tight fit is on the inside member of the assembly, as the pin is installed there becomes a sized and an unsized end of the pin. The end of the pin that has not been inserted through the hole will be larger than the end that has been sized by the hole. Therefore, measure the minimum diameter of the free end to determine the minimum diameter of the free hole in the outside members.

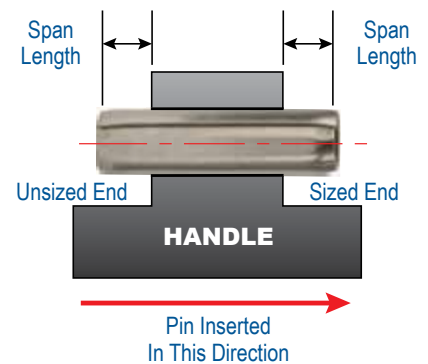

#### FRICION FIT HINGE

To achieve a **friction fit hinge**, the Coiled Pin must create radial tension in all hinge components. Maximum friction will be obtained when all holes are precision matched. Deviation in hole sizes from one component to another will result in the reduction of hinge friction within the assembly. If the manufacturer is unable to maintain the same hole size within each component, the tolerance should be split between the components. It is most common to assign the smaller half of the tolerance to the outside holes and larger half to the inside hole.

The Coiled Pin simplifies design as there is no need to incorporate misalignment between holes to achieve friction, as is the case with rigid Solid Pins. Coiled Pins perform best when installed in straight, properly aligned holes. The Coiled Pin’s spring characteristics can be used to achieve exceptional performance and maintain desired fit and function throughout the life of the product.

Although this article offers general design guidelines, it is recommended that **SPIROL** be consulted to ensure the optimum hinge design is employed for each application.

## Carbon and Alloy Steels

Carbon and alloy steels are the most cost effective and versatile materials available for use in Coiled Pins. These materials are readily available, easy to process, and have very uniform and predictable performance characteristics. The most noticeable limitation to these materials is corrosion protection. In most applications, the normal rust preventative oil is adequate for corrosion protection. In cases where extra protection is necessary, the benefits of coatings and stainless steel must be evaluated.

### High Carbon Steel (B)

High carbon steel is one of the most versatile materials available. It provides very good shear strength and fatigue life suitable for most applications. This material is readily available, and is the most economical of all standard Coiled Pin materials in the absence of any plating or coating. The recommended service temperatures for high carbon steel Coiled Pins are between -45°C (-50°F) and 150°C (300°F). High carbon Coiled Pins are heat treated and have a dry to the touch rust preventative. Additional coatings and finishes can be applied to carbon steel to improve corrosion resistance, however for some applications, it may be more appropriate and cost beneficial to specify stainless steel when a high level of corrosion resistance is required.

### Alloy Steel (W)

For Coiled Pins Ø16mm (Ø5/8") and larger, alloy steel is the standard material. This chrome vanadium alloy provides the same shear strength as high carbon steel, and has the same recommended service temperatures of -45°C (-50°F) to 150°C (300°F). Alloy steel Coiled Pins are also heat treated, and have a dry to the touch rust preventative applied as standard.

## Stainless Steels

In applications where extended corrosion protection is required, stainless steel Coiled Pins are available. There are two basic classifications of stainless steel used for manufacturing Coiled Pins; austenitic stainless and martensitic stainless.

### Austenitic (Nickel) Stainless Steel (D)

Austenitic stainless steel provides the best corrosion protection against normal environmental conditions in both oxygenating and non-oxygenating atmospheres. It withstands fresh water and atmospheric marine conditions very well, and is suitable for many other industrial conditions including acidic environments. However, this material is not heat treated and therefore it is not as strong as the high carbon, alloy, and chrome stainless steels, and does not have the fatigue resistance of those materials. Austenitic stainless steel Coiled Pins are not recommended for high shock and vibration applications, and they should never be installed into hardened holes. Austenitic stainless steel Coiled Pins can be used in temperatures as low as -185°C (-300°F) and as high as 400°C (750°F).

### Martensitic (Chrome) Stainless Steel (C)

Martensitic stainless steel provides both good corrosion resistance and excellent strength and fatigue properties. Martensitic stainless steel is not as corrosion resistant as austenitic stainless in non-oxygenating atmospheres, but it withstands the most common atmospheric and environmental conditions in the presence of free oxygen. The service temperatures for martensitic stainless steel Coiled Pins should be restricted to a minimum of -45°C (-50°F) and a maximum of 260°C (500°F). Martensitic stainless steel Coiled Pins are hardened and stress relieved per exacting standards, and are supplied with a dry to the touch rust preventative as standard.

## STANDARD MATERIALS

TYPE	GRADE	HARDNESS, VICKERS
High Carbon Steel	UNS G10700 / G10740 C67S (1.1231) / C75S (1.1248)	HV 420 – 545
Alloy Steel	UNS G61500 51CrV4 (1.8159)	HV 420 – 545
Stainless Steel, Austenitic (Nickel)	UNS S30200 / S30400 18-8 (1.4310)	Work Hardened
Stainless Steel, Martensitic (Chrome)	UNS S42000 X30Cr13 (1.4028)	HV 460 – 560

**Other material types are available depending on the application requirements. SPIROL has extensive experience with special materials required for unique circumstances.**

Protective finishes are generally used to improve the corrosion resistance of the base metal. There are many different coating types, such as electroplating, chemical conversion, immersion, and mechanical applications. Each of these processes has limitations when applied to Coiled Pins, and depending on the application there may be other concerns. **SPIROL** has extensive experience in recommending and selecting the right combination of material and finish for a variety of applications.

## STANDARD FINISHES

### Plain, Oiled (K)

This finish is a thin coating of dry-to-the touch oil that provides corrosion resistance during storage and shipping. The lubrication reduces the coefficient of friction between the coils to facilitate insertion. Since this lubricating oil is suspended in a carrier which evaporates over time, the pins are dry-to-the-touch and conducive for automatic feeding and assembly.

### Electroplated Zinc (T)

This finish consists of a minimum of 5 $\mu$ m (.0002") thick electrodeposited zinc with a clear trivalent passivation topcoat. Zinc plate is primarily used for cosmetic purposes as this finish yields a bright, silvery appearance on the outside surfaces of the pin. Zinc plating is also commonly used to prevent galvanic corrosion. If atmospheric corrosion protection is required, a stainless steel pin should be considered. While hydrogen embrittlement relief measures are taken during production, designers should consider the risk associated with hydrogen embrittlement before specifying this finish.

## AVAILABLE TO ORDER

### Zinc Phosphate (R)

This zinc phosphate finish has a minimum coating weight of 11 g/m<sup>2</sup>, and is used to provide a good surface on carbon steel for subsequent operations such as painting or oiling. On its own, zinc phosphate provides no corrosion protection. A dry-to-the-touch lubricating oil is added to phosphate coated pins to provide corrosion resistance during storage and shipping. This coating is mostly used for legacy applications, particularly in the firearms and military industries, and is rarely specified on new applications.

For military applications, a different protective oil is applied to the zinc phosphate than that used for commercial products. The more viscous oil is not suitable for automatic feeding.

### Passivated (P)

While stainless steel pins are normally provided with a plain finish, passivation is available to meet application specific requirements. Passivation of Coiled Pins is a process whereby surface contaminants such as embedded tool steel and other free iron particles are removed. The sole purpose of passivation is to remove embedded iron; not to clean the part. SPIROL primarily uses carbide tooling that minimizes the occurrence of imbedded iron particulate, thereby often rendering the passivation process non-value added. In addition, many applications simply do not require passivation. Examples of critical applications where passivation is appropriate are medical devices, components used in the food or drug industry, fuel system applications, and any application requiring a clean environment.

*Available only for stainless steel.*

### Oil Free (F)

Oil free pins undergo a special cleaning process to remove oil residues from the parts. This finish option is typically recommended for pins used in plastics that are incompatible with hydrocarbon based oils and thus susceptible to environmental stress corrosion cracking, as well as for medical or food processing applications.

*Available only for stainless steel.*

***Additional special finishes are available upon request.***



PIN DUTIES	MATERIAL	FINISHES
<b>M</b> Standard	<b>B</b> High Carbon Steel	<b>K</b> Plain, Oiled
<b>H</b> Heavy	<b>C</b> Chrome Stainless Steel	<b>T</b> Electroplated Zinc
<b>L</b> Light	<b>D</b> Nickel Stainless Steel	
	<b>W</b> Alloy Steel	

### Identification Code

Coiled Pin 8mm diameter x 32mm length standard duty/carbon steel/plain finish

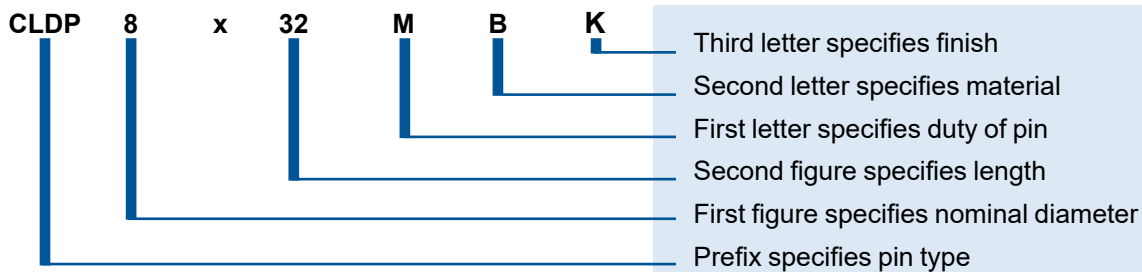

### How to Measure the Diameter of a Coiled Spring Pin

The outside diameter of a Coiled Pin is to be measured with a micrometer from the seam (0° point) through the 90° point. Diameter is to be measured a minimum of one pin diameter in length from the end of the pin.

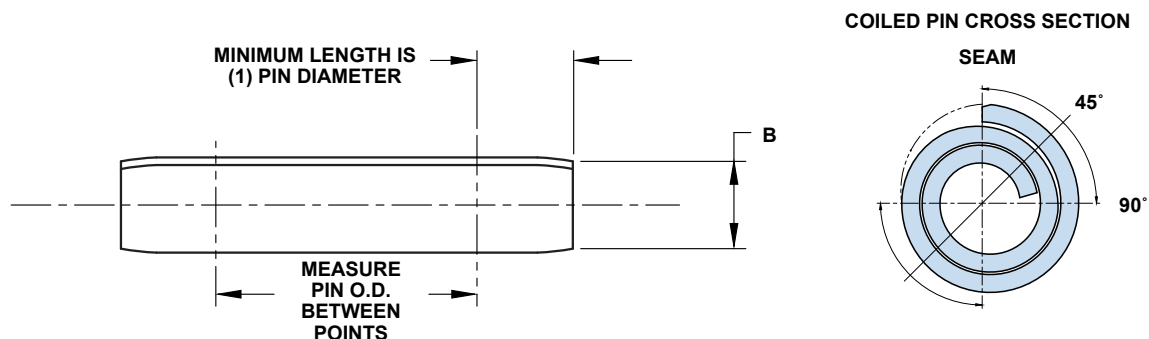

### NOTES

- Standard specifications apply except where otherwise specified.
- All dimensions apply prior to plating.
- Electroplated zinc is not available for pins greater than or equal to 8mm and .312" nominal diameter.
- The standard finish for stainless steel pins is plain. Passivated pins are available at an additional cost.
- Special sizes, duties, materials and finishes, including oil-free pins, are available upon request.

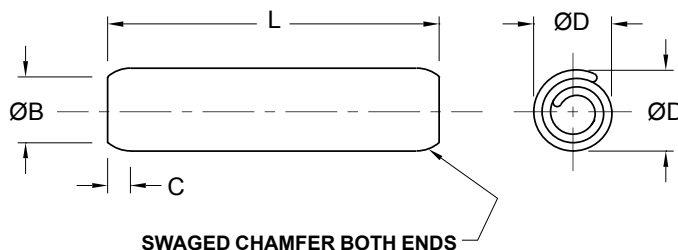

<b>NOMINAL DIAMETER</b>		<b>.031</b>	<b>.039</b>	<b>.047</b>	<b>.052</b>	<b>.062</b>	<b>.078</b>	<b>.094</b>	<b>.109</b>	<b>.125</b>	<b>.156</b>	<b>.187</b>	<b>.219</b>	<b>.250</b>	<b>.312</b>	<b>.375</b>	<b>.437</b>	<b>.500</b>	<b>.625</b>	<b>.750</b>
		1/32		3/64		1/16	5/64	3/32	7/64	1/8	5/32	3/16	7/32	1/4	5/16	3/8	7/16	1/2	5/8	3/4
<b>DIAMETER ØD</b>	<b>MAX.</b>	.035	.044	.052	.057	.072	.088	.105	.120	.138	.171	.205	.238	.271	.337	.403	.469	.535	.661	.787
	<b>MIN.</b>	.033	.041	.049	.054	.067	.083	.099	.114	.131	.163	.196	.228	.260	.324	.388	.452	.516	.642	.768
<b>CHAMFER</b>	<b>B DIA. MAX.</b>	.029	.037	.045	.050	.059	.075	.091	.106	.121	.152	.182	.214	.243	.304	.366	.427	.488	.613	.738
	<b>C LENGTH REF.</b>	.024	.024	.024	.024	.028	.032	.038	.038	.044	.048	.055	.065	.065	.080	.095	.095	.110	.125	.150
<b>RECOMMENDED HOLE SIZE</b>	<b>MAX.</b>	.032	.040	.048	.053	.065	.081	.097	.112	.129	.160	.192	.224	.256	.319	.383	.446	.510	.635	.760
	<b>MIN.</b>	.031	.039	.047	.052	.062	.078	.094	.109	.125	.156	.187	.219	.250	.312	.375	.437	.500	.625	.750

Note: All dimensions apply prior to plating.

### MINIMUM DOUBLE SHEAR STRENGTH LBS.

<b>NOMINAL DIAMETER</b>		<b>.031</b>	<b>.039</b>	<b>.047</b>	<b>.052</b>	<b>.062</b>	<b>.078</b>	<b>.094</b>	<b>.109</b>	<b>.125</b>	<b>.156</b>	<b>.187</b>	<b>.219</b>	<b>.250</b>	<b>.312</b>	<b>.375</b>	<b>.437</b>	<b>.500</b>	<b>.625</b>	<b>.750</b>
		1/32		3/64		1/16	5/64	3/32	7/64	1/8	5/32	3/16	7/32	1/4	5/16	3/8	7/16	1/2	5/8	3/4
<b>CARBON ALLOY STEEL</b>		90	135	190	250	330	550	775	1,050	1,400	2,200	3,150	4,200	5,500	8,700	12,600	17,000	22,500	35,000	50,000
<b>CHROME STAINLESS</b>																				
<b>NICKEL STAINLESS</b>		65	100	145	190	265	425	600	825	1,100	1,700	2,400	3,300	4,300	6,700	9,600	13,300	17,500	—	—

Note: Shear tests performed in accordance with ASME B18.8.2.

### STANDARD LENGTHS

<b>NOMINAL DIAMETER</b>		<b>.031</b>	<b>.039</b>	<b>.047</b>	<b>.052</b>	<b>.062</b>	<b>.078</b>	<b>.094</b>	<b>.109</b>	<b>.125</b>	<b>.156</b>	<b>.187</b>	<b>.219</b>	<b>.250</b>	<b>.312</b>	<b>.375</b>	<b>.437</b>	<b>.500</b>	<b>.625</b>	<b>.750</b>		
		1/32		3/64		1/16	5/64	3/32	7/64	1/8	5/32	3/16	7/32	1/4	5/16	3/8	7/16	1/2	5/8	3/4		
<b>LENGTH</b>	<b>.125</b>	1/8	*		*																	
	<b>.187</b>	3/16	*	*	*																	
	<b>.250</b>	1/4	*	*	*	*	*															
	<b>.312</b>	5/16	*	*	*	*	*	*														
	<b>.375</b>	3/8	*	*	*	*	*	*	*													
	<b>.437</b>	7/16	*	*	*	*	*	*	*	*	*											
	<b>.500</b>	1/2	*	*	*	*	*	*	*	*	*	*										
	<b>.562</b>	9/16			*	*	*	*	*	*	*	*	*									
	<b>.625</b>	5/8		*	*	*	*	*	*	*	*	*	*	*								
	<b>.687</b>	11/16													*							
	<b>.750</b>	3/4					*	*			*	*	*		*							
	<b>.812</b>	13/16																				
	<b>.875</b>	7/8							*		*	*	*		*							
	<b>.937</b>	15/16								*	*	*	*	*		*						
	<b>1.000</b>	1							*		*	*	*	*	*	*						
	<b>1.125</b>	1-1/8								*	*	*	*	*	*	*	*					
	<b>1.250</b>	1-1/4								*	*	*	*	*	*	*	*	*				
	<b>1.375</b>	1-3/8									*	*	*	*	*	*	*	*	*			
	<b>1.500</b>	1-1/2									*	*	*	*	*	*	*	*	*	*		
	<b>1.625</b>	1-5/8									*	*	*	*	*	*	*	*	*	*	*	*
	<b>1.750</b>	1-3/4									*	*	*	*	*	*	*	*	*	*	*	*
	<b>1.875</b>	1-7/8									*	*	*	*	*	*	*	*	*	*	*	*
	<b>2.000</b>	2									*	*	*	*	*	*	*	*	*	*	*	*
	<b>2.250</b>	2-1/4									*	*	*	*	*	*	*	*	*	*	*	*
<b>2.500</b>	2-1/2									*	*	*	*	*	*	*	*	*	*	*	*	
<b>2.750</b>	2-3/4									*	*	*	*	*	*	*	*	*	*	*	*	
<b>3.000</b>	3									*	*	*	*	*	*	*	*	*	*	*	*	
<b>3.250</b>	3-1/4									*	*	*	*	*	*	*	*	*	*	*	*	
<b>3.500</b>	3-1/2									*	*	*	*	*	*	*	*	*	*	*	*	
<b>3.750</b>	3-3/4									*	*	*	*	*	*	*	*	*	*	*	*	
<b>4.000</b>	4									*	*	*	*	*	*	*	*	*	*	*	*	

**Interchangeable Inch and mm Pins**

Inch Diameter	mm Diameter
.031 1/32	0.8
.039	1.0
.047 3/64	1.2
.078 5/64	2.0
.156 5/32	4.0
.312 5/16	8.0
.625 5/8	16.0

Nominal Pin Length		Length Tolerance	
Nominal Pin Size	ø1/32 - 3/8	ø7/16 - 3/4	
L ≤ 2,000	± .010	± .025	
2,000 < L ≤ 3,000	± .015	± .025	
3,000 < L	± .025	± 0.025	
Nominal Pin Length	Pin Straightness Tolerance <sup>1</sup>	Gage Length	Tolerance ±0.005
L ≤ 1,000	.007	1,000	
1,000 < L ≤ 2,000	.010	2,000	
2,000 < L	.013	3,000	

Only available in stainless steel   Available in high carbon and stainless steels   Only available in alloy steel

\* Generally stocked size

<sup>1</sup> Pin must fall through a hole gauge in length equal to the next one-inch increment over the pin length with a hole equal to the maximum specified pin diameter plus the straightness tolerance by its own weight.



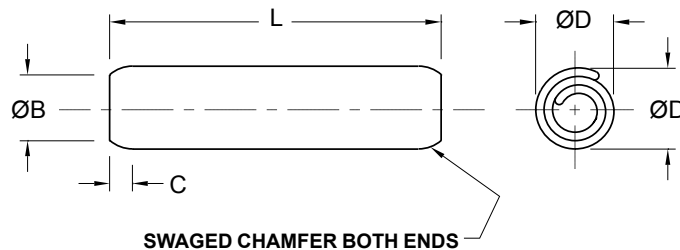

NOMINAL DIAMETER ▶		.062	.078	.094	.109	.125	.156	.187	.219	.250	.312	.375	.437	.500	.625	.750
		1/16	5/64	3/32	7/64	1/8	5/32	3/16	7/32	1/4	5/16	3/8	7/16	1/2	5/8	3/4
DIAMETER ØD	MAX.	.070	.086	.103	.118	.136	.168	.202	.235	.268	.334	.400	.466	.532	.658	.784
	MIN.	.066	.082	.098	.113	.130	.161	.194	.226	.258	.322	.386	.450	.514	.640	.766
CHAMFER	B DIA. MAX.	.059	.075	.091	.106	.121	.152	.182	.214	.243	.304	.366	.427	.488	.613	.738
	C LENGTH REF.	.028	.032	.038	.038	.044	.048	.055	.065	.065	.080	.095	.095	.110	.125	.150
RECOMMENDED HOLE SIZE	MAX.	.065	.081	.097	.112	.129	.160	.192	.224	.256	.319	.383	.446	.510	.635	.760
	MIN.	.062	.078	.094	.109	.125	.156	.187	.219	.250	.312	.375	.437	.500	.625	.750

Note: All dimensions apply prior to plating.

### MINIMUM DOUBLE SHEAR STRENGTH LBS.

NOMINAL DIAMETER ▶	.062	.078	.094	.109	.125	.156	.187	.219	.250	.312	.375	.437	.500	.625	.750
	1/16	5/64	3/32	7/64	1/8	5/32	3/16	7/32	1/4	5/16	3/8	7/16	1/2	5/8	3/4
CARBON CHROME STAINLESS	475	800	1,150	1,500	2,000	3,100	4,500	5,900	7,800	12,000	18,000	23,500	32,000	48,000	70,000
NICKEL STAINLESS	360	575	825	1,150	1,700	2,400	3,500	4,600	6,200	9,300	14,000	18,000	25,000	—	—

Note: Shear tests performed in accordance with ASME B18.8.2.

### STANDARD LENGTHS

NOMINAL DIAMETER ▶		.062	.078	.094	.109	.125	.156	.187	.219	.250	.312	.375	.437	.500	.625	.750
				1/16	5/64	3/32	7/64	1/8	5/32	3/16	7/32	1/4	5/16	3/8	7/16	1/2
LENGTH	.187	3/16	*	*												
	.250	1/4	*	*	*											
	.312	5/16	*	*	*	*										
	.375	3/8	*	*	*	*										
	.437	7/16	*	*	*	*	*									
	.500	1/2	*	*	*	*	*	*								
	.562	9/16	*	*	*	*	*	*	*							
	.625	5/8	*	*	*	*	*	*	*	*						
	.687	11/16									*					
	.750	3/4		*	*	*	*	*	*	*	*					
	.812	13/16										*				
	.875	7/8			*	*	*	*	*	*	*	*				
	.937	15/16											*			
	1.000	1			*	*	*	*	*	*	*	*	*			
	1.125	1-1/8												*		
	1.250	1-1/4					*	*	*	*	*	*	*	*		
	1.375	1-3/8														
	1.500	1-1/2						*	*	*	*	*	*	*		
	1.625	1-5/8													*	
	1.750	1-3/4						*	*	*	*	*	*	*	*	
1.875	1-7/8													*	*	
2.000	2						*	*	*	*	*	*	*	*	*	
2.250	2-1/4									*	*	*	*	*	*	
2.500	2-1/2									*	*	*	*	*	*	
2.750	2-3/4									*	*	*	*	*	*	
3.000	3									*	*	*	*	*	*	
3.250	3-1/4										*	*	*	*	*	
3.500	3-1/2										*	*	*	*	*	
3.750	3-3/4											*	*	*	*	
4.000	4												*	*	*	

Interchangeable Inch and mm Pins			
Inch Diameter		mm Diameter	
.078	5/64	2.0	
.156	5/32	4.0	
.312	5/16	8.0	
.625	5/8	16.0	

Available in high carbon and stainless steels    Only available in alloy steel

\* Generally stocked size

<sup>1</sup> Pin must fall through a hole gauge in length equal to the next one-inch increment over the pin length with a hole equal to the maximum specified pin diameter plus the straightness tolerance by its own weight.

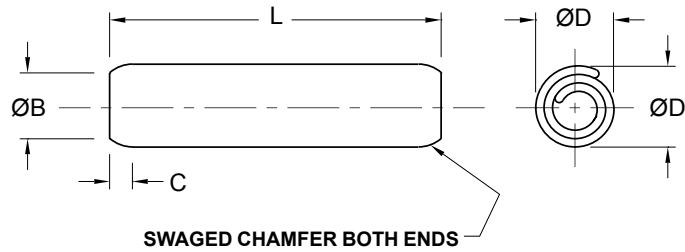

NOMINAL DIAMETER		.062 1/16	.078 5/64	.094 3/32	.109 7/64	.125 1/8	.156 5/32	.187 3/16	.219 7/32	.250 1/4	.312 5/16
DIAMETER ØD	MAX.	.073	.089	.106	.121	.139	.172	.207	.240	.273	.339
	MIN.	.067	.083	.099	.114	.131	.163	.196	.228	.260	.324
CHAMFER	B DIA. MAX.	.059	.075	.091	.106	.121	.152	.182	.214	.243	.304
	C LENGTH REF.	.028	.032	.038	.038	.044	.048	.055	.065	.065	.080
RECOMMENDED HOLE SIZE	MAX.	.065	.081	.097	.112	.129	.160	.192	.224	.256	.319
	MIN.	.062	.078	.094	.109	.125	.156	.187	.219	.250	.312

Note: All dimensions apply prior to plating.

### MINIMUM DOUBLE SHEAR STRENGTH LBS.

NOMINAL DIAMETER		.062 1/16	.078 5/64	.094 3/32	.109 7/64	.125 1/8	.156 5/32	.187 3/16	.219 7/32	.250 1/4	.312 5/16
CARBON		205	325	475	650	825	1,300	1,900	2,600	3,300	5,200
CHROME STAINLESS											
NICKEL STAINLESS		160	250	360	500	650	1,000	1,450	2,000	2,600	4,000

Note: Shear tests performed in accordance with ASME B18.8.2.

### STANDARD LENGTHS

NOMINAL DIAMETER		.062 1/16	.078 5/64	.094 3/32	.109 7/64	.125 1/8	.156 5/32	.187 3/16	.219 7/32	.250 1/4	.312 5/16
LENGTH	.250 1/4										
	.312 5/16										
	.375 3/8										
	.437 7/16										
	.500 1/2										
	.562 9/16										
	.625 5/8										
	.687 11/16										
	.750 3/4										
	.812 13/16										
	.875 7/8										
	.937 15/16										
	1.000 1										
	1.125 1-1/8										
	1.250 1-1/4										
	1.375 1-3/8										
	1.500 1-1/2										
	1.625 1-5/8										
	1.750 1-3/4										
	1.875 1-7/8										
2.000 2											
2.250 2-1/4											
2.500 2-1/2											
2.750 2-3/4											
3.000 3											
3.250 3-1/4											
3.500 3-1/2											
3.750 3-3/4											

**Interchangeable Inch and mm Pins**

Inch Diameter	mm Diameter
.078 5/64	2.0
.156 5/32	4.0
.312 5/16	8.0

Nominal Pin Length	Length Tolerance
Nominal Pin Size	ø1/16 - 5/16
L ≤ 2.000	± .010
2.000 < L ≤ 3.000	± .015
3.000 < L	± .025

Nominal Pin Length	Pin Straightness Tolerance <sup>1</sup>	Gage Length ±0.005
L ≤ 1.000	.007	1.000
1.000 < L ≤ 2.000	.010	2.000
2.000 < L	.013	3.000

Only available in stainless steel      Available in high carbon and stainless steels

<sup>1</sup> Pin must fall through a hole gauge in length equal to the next one-inch increment over the pin length with a hole equal to the maximum specified pin diameter plus the straightness tolerance by its own weight.

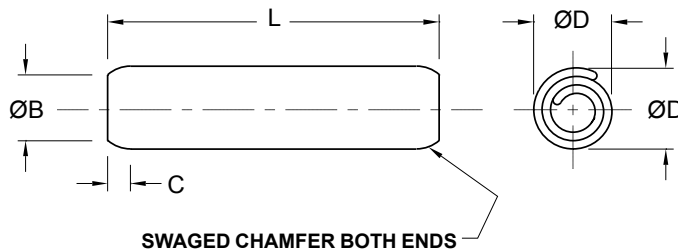

NOMINAL DIAMETER ▶		0.8	1	1.2	1.5	2	2.5	3	3.5	4	5	6	8	10	12	16	20
DIAMETER ØD	MAX.	0.91	1.15	1.35	1.73	2.25	2.78	3.30	3.84	4.40	5.50	6.50	8.63	10.80	12.85	17.00	21.10
	MIN.	0.85	1.05	1.25	1.62	2.13	2.65	3.15	3.67	4.20	5.25	6.25	8.30	10.35	12.40	16.45	20.40
CHAMFER	B DIA. MAX.	0.75	0.95	1.15	1.40	1.90	2.40	2.90	3.40	3.90	4.85	5.85	7.80	9.75	11.70	15.60	19.60
	C LENGTH REF.	0.30	0.30	0.40	0.50	0.70	0.70	0.90	1.00	1.10	1.30	1.50	2.00	2.50	3.00	4.00	4.50
RECOMMENDED HOLE SIZE	MAX.	0.84	1.04	1.24	1.60	2.10	2.60	3.10	3.62	4.12	5.12	6.15	8.15	10.15	12.18	16.18	20.21
	MIN.	0.80	1.00	1.20	1.50	2.00	2.50	3.00	3.50	4.00	5.00	6.00	8.00	10.00	12.00	16.00	20.00

Note: All dimensions apply prior to plating.

### MINIMUM DOUBLE SHEAR STRENGTH kN

NOMINAL DIAMETER ▶		0.8	1	1.2	1.5	2	2.5	3	3.5	4	5	6	8	10	12	16	20
CARBON ALLOY STEEL		0.40	0.60	0.90	1.45	2.50	3.90	5.50	7.50	9.60	15	22	39	62	89	155	250
CHROME STAINLESS																	
NICKEL STAINLESS		0.30	0.45	0.65	1.05	1.90	2.90	4.20	5.70	7.60	11.50	16.80	30	48	67	—	—

Note: Shear tests performed in accordance ASME B18.8.3M and ISO 8749.

### STANDARD LENGTHS

NOMINAL DIAMETER ▶		0.8	1	1.2	1.5	2	2.5	3	3.5	4	5	6	8	10	12	16	20
4																	
5		*	*	*	*												
6		*	*	*	*	*											
8		*	*	*	*	*	*										
10		*	*	*	*	*	*	*									
12		*	*	*	*	*	*	*	*								
14					*	*	*	*	*	*							
16					*	*	*	*	*	*	*						
18						*	*	*	*	*	*	*					
20						*	*	*	*	*	*	*	*				
22						*	*	*	*	*	*	*	*	*			
24						*	*	*	*	*	*	*	*	*	*		
26							*	*	*	*	*	*	*	*	*		
28								*	*	*	*	*	*	*	*	*	
30								*	*	*	*	*	*	*	*	*	*
32									*	*	*	*	*	*	*	*	*
35										*	*	*	*	*	*	*	*
40										*	*	*	*	*	*	*	*
45										*	*	*	*	*	*	*	*
50										*	*	*	*	*	*	*	*
55											*	*	*	*	*	*	*
60												*	*	*	*	*	*
65													*	*	*	*	*
70														*	*	*	*
75															*	*	*
80																*	*
85																	*
90																	*
95																	*
100																	*

**Interchangeable mm and Inch Pins**

mm Diameter	Inch Diameter
0.8	.031 1/32
1.0	.039
1.2	.047 3/64
2.0	.078 5/64
4.0	.156 5/32
8.0	.312 5/16
16.0	.625 5/8

Nominal Pin Length		Length Tolerance	
Nominal Pin Size	ø0.8 - 10	ø12 - 20	
L ≤ 10	±0.25	N/A	
10 < L ≤ 50	±0.5	±0.5	
50 < L	±0.75	±0.75	

  

Pin Straightness Tolerance <sup>1</sup>		
Gage Hole Diameter		
Specified Maximum Pin Diameter Plus:		
Nominal Pin Length	Min.	Max.
		±0.15
L ≤ 24	0.18	0.2
24 < L ≤ 50	0.3	0.34
50 < L	0.42	0.48

  Only available in stainless steel  
   Available in high carbon and stainless steels  
   Only available in alloy steel

\* Generally stocked size

<sup>1</sup> Pin must fall through the gage by its own weight.

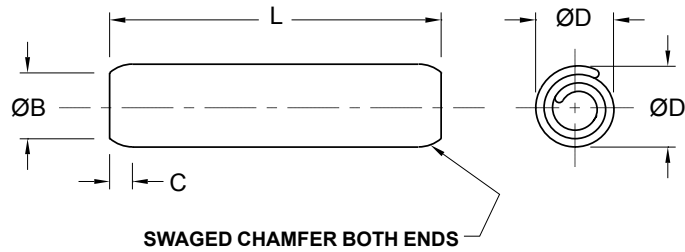

NOMINAL DIAMETER ▶		1.5	2	2.5	3	3.5	4	5	6	8	10	12	16	20
DIAMETER ØD	MAX.	1.71	2.21	2.73	3.25	3.79	4.30	5.35	6.40	8.55	10.65	12.75	16.90	21.00
	MIN.	1.61	2.11	2.62	3.12	3.64	4.15	5.15	6.18	8.25	10.30	12.35	16.40	20.40
CHAMFER	B DIA. MAX.	1.40	1.90	2.40	2.90	3.40	3.90	4.85	5.85	7.80	9.75	11.70	15.60	19.60
	C LENGTH REF.	0.50	0.70	0.70	0.90	1.00	1.10	1.30	1.50	2.00	2.50	3.00	4.00	4.50
RECOMMENDED HOLE SIZE	MAX.	1.60	2.10	2.60	3.10	3.62	4.12	5.12	6.15	8.15	10.15	12.18	16.18	20.21
	MIN.	1.50	2.00	2.50	3.00	3.50	4.00	5.00	6.00	8.00	10.00	12.00	16.00	20.00

Note: All dimensions apply prior to plating.

### MINIMUM DOUBLE SHEAR STRENGTH kN

NOMINAL DIAMETER ▶	1.5	2	2.5	3	3.5	4	5	6	8	10	12	16	20
CARBON ALLOY STEEL CHROME STAINLESS	1.90	3.50	5.50	7.60	10	13.50	20	30	53	84	120	210	340
NICKEL STAINLESS	1.45	2.50	3.80	5.70	7.60	10	15.50	23	41	64	91	—	—

Note: Shear tests performed in accordance ASME B18.8.3M and ISO 8749.

### STANDARD LENGTHS

NOMINAL DIAMETER ▶	1.5	2	2.5	3	3.5	4	5	6	8	10	12	16	20
4	*												
5	*	*											
6	*	*	*										
8	*	*	*	*									
10	*	*	*	*		*							
12	*	*	*	*		*							
14	*	*	*	*		*	*						
16	*	*	*	*		*	*	*					
18		*	*	*		*	*	*					
20		*	*	*		*	*	*	*				
22		*	*	*		*	*	*	*				
24		*	*	*		*	*	*	*				
26			*	*		*	*	*	*	*			
28				*		*	*	*	*	*			
30				*		*	*	*	*	*	*		
32						*	*	*	*	*	*		
35						*	*	*	*	*	*		
40						*	*	*	*	*	*		
45						*	*	*	*	*	*		
50						*	*	*	*	*	*		
55								*	*	*	*		
60								*	*	*	*		
65								*	*	*	*		
70								*	*	*	*		
75								*	*	*	*		
80								*	*	*	*		
85								*	*	*	*		
90								*	*	*	*		
95								*	*	*	*		
100								*	*	*	*		

Interchangeable mm and Inch Pins

mm Diameter	Inch Diameter
2.0	.078 5/64
4.0	.156 5/32
8.0	.312 5/16
16.0	.625 5/8

Nominal Pin Length	Length Tolerance	
Nominal Pin Size	ø1.5 - 10	ø12 - 20
L ≤ 10	±0.25	N/A
10 < L ≤ 50	±0.5	±0.5
50 < L	±0.75	±0.75

  

Pin Straightness Tolerance <sup>1</sup>		
Gage Hole Diameter		
Specified Maximum Pin Diameter Plus:		
Nominal Pin Length	Min.	Max.
		±0.15
L ≤ 24	0.18	0.2
24 < L ≤ 50	0.3	0.34
50 < L	0.42	0.48

Available in high carbon and stainless steels    Only available in alloy steel

\* Generally stocked size

<sup>1</sup> Pin must fall through the gage by its own weight.

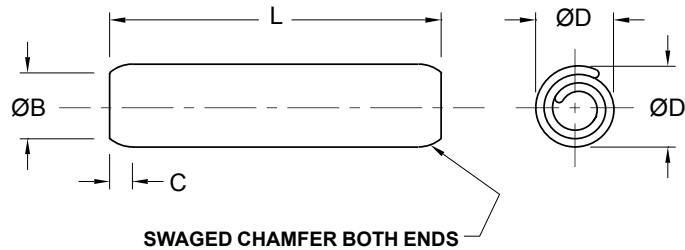

NOMINAL DIAMETER		1.5	2	2.5	3	3.5	4	5	6	8
DIAMETER ØD	MAX.	1.75	2.28	2.82	3.35	3.87	4.45	5.50	6.55	8.65
	MIN.	1.62	2.13	2.65	3.15	3.67	4.20	5.20	6.25	8.30
CHAMFER	B DIA. MAX.	1.40	1.90	2.40	2.90	3.40	3.90	4.85	5.85	7.80
	C LENGTH REF.	0.50	0.70	0.70	0.90	1.00	1.10	1.30	1.50	2.00
RECOMMENDED HOLE SIZE	MAX.	1.60	2.10	2.60	3.10	3.62	4.12	5.12	6.15	8.15
	MIN.	1.50	2.00	2.50	3.00	3.50	4.00	5.00	6.00	8.00

Note: All dimensions apply prior to plating.

### MINIMUM DOUBLE SHEAR STRENGTH kN

NOMINAL DIAMETER		1.5	2	2.5	3	3.5	4	5	6	8
CARBON										
ALLOY STEEL		0.80	1.50	2.30	3.30	4.50	5.70	9	13	23
CHROME STAINLESS										
NICKEL STAINLESS		0.65	1.10	1.80	2.50	3.40	4.40	7	10	18

Note: Shear tests performed in accordance ASME B18.8.3M and ISO 8749.

### STANDARD LENGTHS

NOMINAL DIAMETER		1.5	2	2.5	3	3.5	4	5	6	8
6										
8										
10										
12										
14										
16										
18										
20										
22										
24										
26										
28										
30										
32										
35										
40										
45										
50										
55										
60										
65										
70										
75										
80										
85										
90										
95										

Interchangeable mm and Inch Pins	
mm Diameter	Inch Diameter
2.0	.078 5/64
4.0	.156 5/32
8.0	.312 5/16

Nominal Pin Length		Length Tolerance	
Nominal Pin Size		ø1.5 - 8	
L ≤ 10		±0.25	
10 < L ≤ 50		±0.5	
50 < L		±0.75	

Pin Straightness Tolerance <sup>1</sup>			
Gage Hole Diameter			
Specified Maximum Pin Diameter Plus:			
Nominal Pin Length	Min.	Max.	Gage Length ±0.15
L ≤ 24	0.18	0.2	25
24 < L ≤ 50	0.3	0.34	50
50 < L	0.42	0.48	75

Only available in stainless steel
  Available in high carbon and stainless steels

<sup>1</sup> Pin must fall through the gage by its own weight.

**SPIROL's** Application Engineers are ready to assist you in selecting the most appropriate Coiled Spring Pin to meet your application requirements. During our engineering review, if a standard product cannot meet your application or assembly requirements, our Engineers will design a special product to meet your needs. Many specials are derivations of our standard products and can be produced with minimal investment in development. Others are completely unique and may require a larger investment in development or special processing.

The earlier that we are brought into the design process, the more likely we are able to equip you with one of our 30,000 standard items that typically ship from stock

### **SERIES 500 EXTRA LIGHT DUTY PINS**



The Series 500 Extra Light Duty Coiled Pins were specifically designed for use in soft or fragile materials. The 1½ coil formation ensures that the radial force exerted against the hole wall does not exceed the strength of the hole material to prevent deformation. These pins are also an economical solution where pin strength is not a major design consideration. Typical applications for Series 500 Pins include: hinge pins in plastic or ceramic assemblies, alignment pins, and fastening applications where the hole is close to an edge of an assembly component.

### **SERIES 600 SUPERFLEX PINS**



This pin, with a loosely wrapped outer coil and a diameter at 90° to the seam equal to the hole size has a low insertion force and enhanced flexibility after insertion. The Superflex Pin eliminates insertion problems associated with hardened holes with sharp edges. The pin is not distorted during insertion and maintains its straightness. One example of a great application for the Superflex Pin is when the pin is inserted into a shaft with both ends exposed for engagement into a slotted clutch component.

### **316 STAINLESS STEEL COILED SPRING PINS**



SPIROL manufactures Coiled Spring Pins out of 316 stainless steel to meet specific application requirements. Type 316 stainless steel is similar to 302/304 stainless steel with a slightly higher nickel content and the addition of molybdenum. The molybdenum content increases the chemical resistance of this alloy greatly. 316 exhibits superior pitting resistance against sea water, acetic acid vapors, chlorides, sodium and calcium brines, hypochlorite solutions, phosphoric acid, and the sulfite liquors and sulfurous acids used in the paper and pulp industry. This alloy is also austenitic, non-magnetic and non-hardenable using conventional methods. 316 stainless steel has better mechanical properties at elevated temperatures than 302/304 and offers excellent mechanical integrity at subzero temperatures. Typical applications for SPIROL's 316 Stainless Steel Coiled Pins include the following: marine, processing equipment, industrial, oil and gas and medical.

**All special Coiled Pins are subject to minimum order quantities.**

While **SPIROL** Coiled Pins can be easily installed with a hammer or with an arbor press, we recognize that an essential factor in reducing the overall cost of components is having trouble-free assembly. Automation increases assembly efficiency, particularly with awkward or small components, and combining operations such as drilling and pinning increases productivity and eliminates misaligned holes.

SPIROL is the **only** manufacturer of Coiled Pins that designs, builds and supports a comprehensive standard line of Pin Installation Equipment ranging from manual to fully automatic modules. We are experts in adapting our standard modules to customer specific applications, including fixturing and holding components for both a quality installation and ease-of-assembly. Our time-tested, proven and reliable equipment can be equipped with options such as rotary index tables, pin sensing, force monitoring, and drilling and pinning combinations for enhanced productivity, heightened process control and error proofing.



Model PR

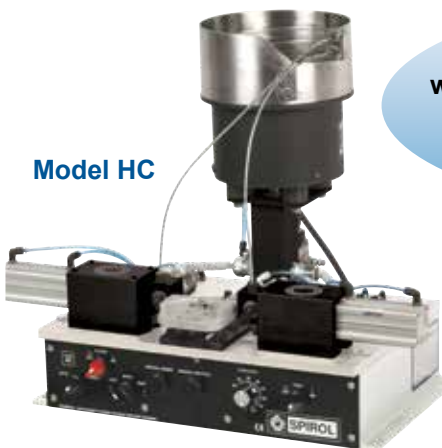

Model HC

**SPIROL guarantees** that our equipment will enhance your productivity and reduce your total manufacturing costs by offering the **only** performance warranty in the industry.



Model DP



Model CR

Protective eyewear is recommended during pin installation.



Model PM

The unique features of the Coiled Pin in combination with automated assembly solutions drive down cost for the manufacturer. When all factors are considered such as installation quality, component damage, reduced warranty claims, inspection during installation and throughput enhancement, SPIROL's Coiled Pin is the pin of choice to provide a robust high-quality joint at the lowest manufacturing cost.



**Innovative fastening solutions.  
Lower assembly costs.**

## Technical Centres

**Americas SPIROL Canada**  
3103 St. Etienne Boulevard  
Windsor, Ontario N8W 5B1 Canada  
Tel. +1 519 974 3334  
Fax. +1 519 974 6550

**SPIROL International Corporation**  
30 Rock Avenue  
Danielson, Connecticut 06239 U.S.A.  
Tel. +1 860 774 8571  
Fax. +1 860 774 2048

**SPIROL Shim Division**  
321 Remington Road  
Stow, Ohio 44224 U.S.A.  
Tel. +1 330 920 3655  
Fax. +1 330 920 3659

**SPIROL Mexico**  
Avenida Avante #250  
Parque Industrial Avante Apodaca  
Apodaca, N.L. 66607 Mexico  
Tel. +52 81 8385 4390  
Fax. +52 81 8385 4391

**SPIROL Brazil**  
Rua Mafalda Barnabé Soliane, 134  
Comercial Vitória Martini, Distrito Industrial  
CEP 13347-610, Indaiatuba, SP, Brazil  
Tel. +55 19 3936 2701  
Fax. +55 19 3936 7121

**Europe SPIROL United Kingdom**  
17 Princewood Road  
Corby, Northants  
NN17 4ET United Kingdom  
Tel: +44 (0) 1536 444800  
Fax: +44 (0) 1536 203415

**SPIROL France**  
Cit  de l'Automobile ZAC Croix Blandin  
18 Rue L na Bernstein  
51100 Reims, France  
Tel: +33 (0) 3 26 36 31 42  
Fax: +33 (0) 3 26 09 19 76

**SPIROL Germany**  
Ottostr. 4  
80333 Munich, Germany  
Tel: +49 (0) 89 4 111 905 71  
Fax: +49 (0) 89 4 111 905 72

**SPIROL Spain**  
Plantes 3 i 4  
Gran Via de Carles III, 84  
08028, Barcelona, Spain  
Tel/Fax: +34 932 71 64 28

**SPIROL Czech Republic**  
Evropsk 2588 / 33a  
160 00 Prague 6-Dejvice  
Czech Republic  
Tel: +420 226 218 935

**SPIROL Poland**  
ul. Solec 38 lok. 10  
00-394, Warsaw, Poland  
Tel. +48 510 039 345

**Asia Pacific SPIROL Asia Headquarters**  
1st Floor, Building 22, Plot D9, District D  
No. 122 HeDan Road  
Wai Gao Qiao Free Trade Zone  
Shanghai, China 200131  
Tel: +86 (0) 21 5046-1451  
Fax: +86 (0) 21 5046-1540

**SPIROL Korea**  
16th Floor, 396 Seocho-daero,  
Seocho-gu, Seoul, 06619, South Korea  
Tel: +82 (0) 10 9429 1451

e-mail: [info-ca@spirol.com](mailto:info-ca@spirol.com)

**SPIROL.ca**



**Coiled Spring Pins**



**Slotted Spring Pins**



**Solid Pins**



**Alignment Dowels /  
Bushings**

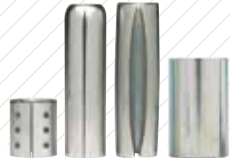

**Spacers & Rolled  
Tubular Components**

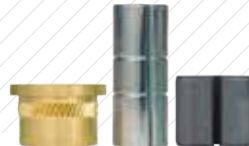

**Compression  
Limiters**



**Threaded Inserts  
for Plastics**



**Railroad Nuts**



**Disc Springs**



**Precision Shims &  
Thin Metal Stampings**



**Precision Washers**



**Parts Feeding  
Technology**



**Pin Installation  
Technology**



**Insert Installation  
Technology**



**Compression Limiter  
Installation Technology**

Please refer to [www.SPIROL.ca](http://www.SPIROL.ca) for current specifications and standard product offerings.

SPIROL offers complimentary Application Engineering support! We will assist on new designs as well as help resolve issues, and recommend cost savings on existing designs. Let us help by visiting **Application Engineering Services** on **SPIROL.ca**.